

Integrated Weed Management

Experiential learning modules for sustainable intensification and agricultural service provision

BOOK IX

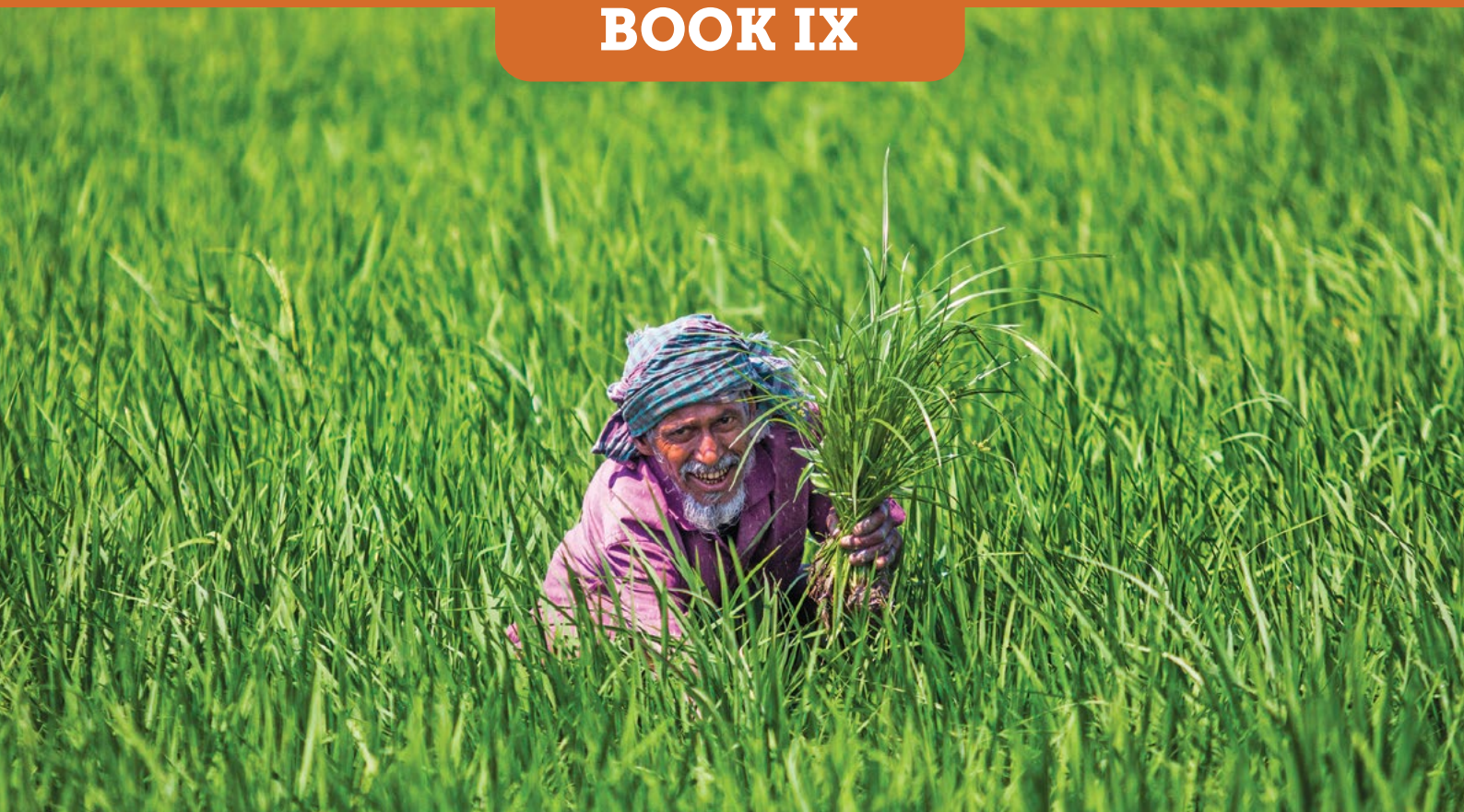

Timothy J. Krupnik, Kamrun Naher, Shafiq Islam, Muhammad Arshadul Hoque,
Apurba Roy, Virender Kumar, Shamim Ara Begum, Israil Hossain,
Khaled Hossain, Sumona Shahrin, Mahesh Kumar Gathala,
Anil Shrestha, Sheikh Md. Nazim Uddin



Integrated Weed Management

Experiential learning modules for sustainable intensification and agricultural service provision

BOOK IX

Timothy J. Krupnik
Kamrun Naher
Shafiq Islam
Muhammad Arshadul Hoque
Apurba Roy
Virender Kumar
Shamim Ara Begum
Israil Hossain
Khaled Hossain
Sumona Shahrin
Mahesh Kumar Gathala
Anil Shrestha
Sheikh Md. Nazim Uddin



Cereal Systems Initiative for South Asia

INTEGRATED WEED MANAGEMENT

Experiential learning modules for sustainable intensification and agricultural service provision (Book IX).

Timothy J. Krupnik¹, Kamrun Naher^{1,2}, Shafiq Islam¹, Muhammad Arshadul Hoque³, Apurba Roy¹, Virender Kumar⁴, Shamim Ara Begum¹, Israil Hossain³, Khaled Hossain¹, Sumona Shahrin⁷, Mahesh Kumar Gathala¹, Anil Shrestha⁵ and Sheikh Md. Nazim Uddin⁶

- ¹ International Maize and Wheat Improvement Center (CIMMYT). House 10/B, road 53, Gulshan 2, Dhaka, 1213, Bangladesh.
- ² Food and Agriculture Organization (FAO) of the United Nations. House 37, road 8, Dhanmondi R/A, Dhaka 1205, Bangladesh.
- ³ Farm Machinery and Post Harvest Engineering (FMPE) Division, Bangladesh Agricultural Research Institute (BARI), Joydebpur, Gazipur 1701, Bangladesh.
- ⁴ International Rice Research Institute (IRRI). DAPO Box 7777, Metro Manila 1301, Philippines.
- ⁵ Department of Plant Science, California State University. 2415 E, San Ramon Ave. MS A/S 72, Fresno, CA 93740, USA.
- ⁶ Department of Agricultural Extension. Khamarbari, Farmgate, Dhaka-1215, Bangladesh.
- ⁷ Wageningen University.

The International Maize and Wheat Improvement Center (CIMMYT) is the global leader on publicly funded maize and wheat research and related farming systems. Headquartered near Mexico City, Mexico, CIMMYT works with hundreds of partners throughout the developing world to sustainably increase the productivity of maize and wheat cropping systems, thus improving global food security and reducing poverty. CIMMYT is a member of the CGIAR Consortium and leads the CGIAR Research Programs on MAIZE and WHEAT. The Center receives support from national governments, foundations, development banks and other public and private agencies.

This work is licensed under the Creative Commons Attribution 4.0 International License.

To view a copy of this license, visit <http://creativecommons.org/licenses/by/4.0/> or

send a letter to Creative Commons, PO Box 1866, Mountain View, CA 94042, USA. The

designations employed in the presentation of materials in this publications do not imply the expression of any opinion whatsoever on the part of CIMMYT or its contributory organizations concerning the legal status of any country, territory, city, or area, or of its authorities, or concerning the delimitation of its frontiers or boundaries. The opinion expressed are those of the author (s), and are not necessarily those of CIMMYT or its partners. CIMMYT encourages fair use of this material with proper citation.



Correct Citation: Krupnik, T. J., Naher, K., Islam, S., Hoque, M. A., Roy, A., Kumar, V., Begum, S. A., Hossain, I., Hossain, K., Shahrin, S., Gathala, M. K., Shrestha, A., Uddin, S. M. N. 2020. Integrated weed management: *Experiential learning modules – Book IX*. Mexico, D.F.: CIMMYT.

Photo Credit:

Cover & Back: Ranak Martin/CIMMYT

Inner drawings: Shaha Alam Jewel, Khaled Hossain, and Shabita Barma

Publication Design: Mohammad Shahidul Haque Khan

Published by: CIMMYT- Bangladesh. House 10/B, Road 53, Gulshan 2, Dhaka 1212 Tel (Land/Fax): +880 2 9896676, +880 2 9894278; Post: P.O. No. 6057, Gulshan, Dhaka 1212, Bangladesh. For more information by email: t.krupnik@cgiar.org

Printed in Bangladesh. Published in 2020

This publication was developed by the International Maize and Wheat Improvement Center (CIMMYT) as part of the Cereal Systems Initiative for South Asia (CSISA) project, Phase III which is made possible with generous support of the United States Agency for International Development Mission in Bangladesh and the Bill & Melinda Gates Foundation.

The Cereal Systems Initiative for South Asia (CSISA) was established in 2009 to promote durable change at scale in South Asia's cereal-based cropping systems. Operating in rural 'innovation hubs' in Bangladesh, India and Nepal, CSISA works to increase the adoption of various resourceconserving and climate-resilient technologies, and improve farmers' access to market information and enterprise development. CSISA supports women farmers by improving their access and exposure to modern and improved technological innovations, knowledge and entrepreneurial skills. By continuing to work in synergy with regional and national efforts, collaborating with myriad public, civil society and private-sector partners, CSISA aims to benefit more than 8 million farmers by the end of 2020.



USAID
FROM THE AMERICAN PEOPLE

BILL & MELINDA
GATES *foundation*

This publication was made possible through the support provided by the United States Agency for International Development (USAID) and the Bill & Melinda Gates Foundation. The contents and opinions expressed herein are those of the author(s) and do not necessarily reflect the views of the US Agency for International Development or the United States Government and the Bill & Melinda Gates Foundation and shall not be used for advertising or product endorsement purposes.

Table of Contents

Introduction

Experiential education and training format	1
The field is the best classroom for learning about weed ecology and management	1
Organization of this book	2
Training aims and objectives: Integrated Weed Management	3
Who is this training designed for?	3
Key considerations for training	4
Course preparation, duration, materials, and setting	5
Planning and preparation for the training	5
Training venue	5
Required training aids	5
Session 1: Introduction and training objectives	7
Session 2: Weeds and integrated weed management	9
Session 3: Sprayers, spray technology, and sprayer maintenance	11
Session 4: Practical calibration	13
Session 5: Practical exercise on spraying techniques	15
Session 6: Review, post-test, and closing	17

Flip charts and hand-out materials

Session 1: Integrated weed management introduction and training objectives	19
Session 2: Different types of weeds and weed management practices	21
Session 3: Sprayers, spray technology, and sprayer maintenance	25
Session 4: Practical calibration	47
Session 5: Practical herbicide spraying exercise	64
Session 6: Review, post-test and closing	77

Annexes

84

Foreword

The countries of South Asia are built on agricultural foundations. Our farmers play a crucial part in providing food and nourishment to our people. They however face a number of consistent threats to maintaining the productivity of their fields and farms. Pests are one of these threats, and among them, weeds in particular are important because they can cause large yield losses. They can also result in many hours of drudgery when farmers have to spend many hours removing weeds by hand. Conversely, where farmers use herbicides to control weeds, improper knowledge of chemical handling and application safety can be problematic for both human and environmental health. This is in particular important in the aquatic environment of a rice field, where many non-target fish and amphibian species can be affected by careless agrochemical use.

Farmers can benefit from learning and improved knowledge on how to better manage weeds in an integrated way. Increased knowledge means that farmer will have available a wealth of information on what tools, techniques, and products might be needed to improve weed management and to reduce weed inflicted yield losses. The same information is needed for agricultural input dealers, extension agents, and others working to technically support farming communities. An improved understanding of weed ecology and an ability to understand which weed species are most problematic, and to comprehend the significance of this information when selecting from weed control techniques is also crucial.

In order to better grasp the importance of integrated weed management, farmers will benefit most from hands-on and experiential learning. Such learning is best facilitated using the field as the classroom. The set of training modules you hold in your hands has been developed through a collaborative effort between Bangladesh's Department of Agricultural Extension (DAE), the Bangladesh Agricultural Research Institute, the International Maize and Wheat Improvement center, the International Rice Research Institute, and the Department of Plant Sciences at California State University in the United States as part of third phase of the Cereal Systems Initiative for South Asia (CISISA) project. While the modules were developed mainly in Bangladesh, the general approach and principles described in each learning session are widely applicable. They can also be used to educate farmers in a variety of other countries where smallholder agriculture predominates. Everything you need to know about training farmers in weed management can be found here – from how to conduct training sessions, to lists of required materials, to flip charts that can also be made into Power-Point slides, all along side sets of practical field exercises that will boost farmers' learning.

For these reasons, I am very proud to introduce and support these training modules, which are part of a set of comprehensive training resources on scale-appropriate machinery and resource-conserving agricultural practices for smallholder farmers in cereal-based farming systems. Use of these modules fits seamlessly with the DAE's vision is to provide ecofriendly, safe, climate resilient, sustainable, and productive good agricultural practices while sustaining natural resources to ensure food security and commercial agriculture with a view towards accelerating socio-economic development. For this reason, these modules can be widely used by DAE staff in the field, in addition to by NGO and private sector trainers in different organizations, with the goal of helping farming communities to achieve rural development.

Sincerely,



Md. Hamidur Rahman
Director General – Department of Agricultural Extension – Bangladesh

Introduction

Globally, weeds cause higher agricultural production losses than other agricultural pests. In a systematic review of the evidence on crop production losses, Oerke (2005) wrote that “Estimates on potential and actual losses despite the current crop protection practices are given for wheat, rice, maize, potatoes, soybeans, and cotton ... weeds produced the highest potential loss (34%), with animal pests and pathogens being less important (losses of 18 and 16%)”¹. Weeds are therefore a consistent headache to farmers. They interfere with crops by competing for soil nutrients, light, and water. They are particularly problematic when crops are directly sown by machine, or under conditions of reduced tillage. They also constrain farmers with respect to their time and labor, and constitute an important production cost.

This book covers critical topics for the principles and practice of integrated weed management (IWM) in the context of smallholder farming in the tropics, with emphasis on experiential and hands-on learning. The materials within provide a guide for training facilitators to conduct a rapid one-day training on IWM, including detailed instructions on how to facilitate a training, training material requirements, flip charts to facilitate discussions, and pre- and post-tests for training participants. IWM is better learned through multiple training sessions or as part of a farmer field school than in an individual one-day training. Hence while this book details several modular training sessions that can be conducted consecutively over a single day, they can also be broken up and applied as individual modules during a season long farmer field school, or for more targeted training sessions. Note also that training in IWM is needed prior to training farmers, machinery service providers (farmers who own equipment or machinery, such as seeding equipment or herbicide sprayers, and charge other farmers for their use on an affordable fee-for-service basis), or others in aspects of direct seeding or the practicalities of conservation agriculture (CA, such as zero- or strip-tillage). In the latter case, the cultural weed control concept of crop rotation fits nicely with CA principles. For this reason, training facilitators are encouraged to use these IWM modules prior to attempting to train farmers or service providers on these more advanced crop establishment techniques. IWM techniques are also commonly incorporated into the packages of services that agricultural service providers make available for farmer clients.

Experiential education and training format

This training is meant to be discussion based and experiential, and to encourage critical reflection and learning among participants. This means that while the facilitator will have to present materials, the format in which this should be done should be horizontal and participatory. We also underscore that farmers and agricultural machinery service providers, who are the target of these trainings, are experts – they work daily in their fields and have considerably more experience than most university educated technicians, researchers, or extension agents. Listening to their opinions and working with them to facilitate learning will enhance the quality of a training session. In this sense, it is the responsibility of a training facilitator to elicit training participants’ input, opinions, and ideas, and to use them interactively to shape discussion and learning. The technical materials included in this document are therefore a guide to supplement farmers’ and agricultural machinery service providers’ already in-depth knowledge.

The training format used here is based loosely on the experiential learning cycle described by Kolb (1984)², who proposed that adults learn differently than children, with learning based on having a concrete experience, reflecting on this experience, conceptualizing of this experience, and then experimenting, after which the cycle of learning is repeated. He further hypothesized that there are generally four types of adult learners and learning styles which should be accommodated, including people who learn by watching demonstrations (which he called divergers), those who learn by thinking, reading, and watching (assimilators), those who learn by hands-on thinking and doing (convergers), and those who learn by doing (accommodators). Well-designed trainings should accommodate each participant’s individual learning style, by providing a mixture of lecture and discussion, reading or visual material, hands-on experiential and experimental opportunities, and opportunities to watch demonstrations and to learn. Kolb’s theories have been widely researched and validated in a number of contexts, and provide a solid foundation for educational programs aimed at experienced farmers and agricultural service providers, as well as farmer field school oriented learning. In this training, we loosely attempt to formulate Kolb’s learning styles as shown below.

¹ Oerke, E-C. 2005. Crop losses to pests. *Journal of Agricultural Science*. 44:21-42.

² Kolb, D.A., 1984. *Experiential Learning: Experience as the Source of Learning and Development*. Prentice-Hall, Englewood Cliffs, NJ.

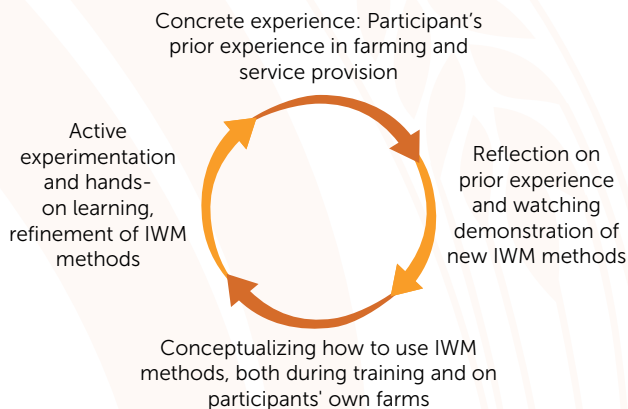

Above: Kolb's (1986) experiential learning cycle as loosely applied in the IWM training modules.

Facilitators should therefore at every step of the process work to generate discussion, hands-on learning through activities, provide opportunities to demonstrate and show how to use IWM approaches, and to encourage critical but constructive reflection among the training participants. There is a certain art to this process, and facilitators should practice with their peers different techniques for eliciting discussion among trainees.

Here's some examples of how to ask questions of the training participants that will encourage them to think and critically reflect on the training material:

1. **Arrange seating in a circle, not like in a classroom:** Circular seating arrangements encourage participants and facilitators to interact as equals, and improve the potential for discussion.
2. **Rather than ask closed questions, as open ones:** For example rather than ask "what are the different ways that crops and weeds compete", ask "what is the significance and implications for your farm of the ways that crops and weeds compete"? Participants may require some additional encouragement to discuss this question, but gently push them towards realizing the answer.
3. **Prompt questions that have open and multiple answers:** For example, rather than ask training participants "what happens if the pressure regulation on a sprayer is not working evenly", ask "if the pressure regulation on a sprayer is not working, what are the implications for weed control, yield, and farmers' profits"?
4. **Pick a particular participant to give an answer:** Rotate among students, picking different ones and asking them or a group of students to give an answer to a question. It may take time for them to

give an answer, but allow them to work through the process of reflection and coming up with their response. Then engage and discuss their response with them, and ask others for their thoughts on their response. But if a particular participant is naturally quiet or reserved, avoid asking them too many questions. The goal is to encourage an active learning atmosphere, but not to make participants feel uncomfortable.

5. **Most importantly, ask logical questions based on the training materials:** This seems like a simple point, but it is important to stay on topic and assure that participants are equipped to respond to questions.
6. **Provide space for underrepresented students to speak:** In many trainings, men speak over women or dominate conversation. Members of a particular religious group or caste may also speak over those who are not part of this group. Facilitators should recognize this, and work to give space to underrepresented groups to learn and speak. This may require specifically asking other participants to wait to reply to give them an opportunity to contribute.

The field is the best classroom for learning about weed ecology and management

Trainings are also to be held primarily outside and in the field, where participants are encouraged to learn with their own hands how to work with integrated weed management principles and tools. It is only by taking weed samples and examining them that trainees can learn how to identify weeds by class or species. For this reason, the flip chart material provided in this book can be printed on large paper and taken to farmers' fields, where electricity for power points or other formats may not be available.

Emphasis should be given to these participatory activities throughout the training. Last but not least, training and education does not end at the conclusion of the day. Participants should be encouraged to experiment with, learn from, modify and adapt IWM techniques on their own farm, emulating the cycle of continual learning articulated by Kolb. For this reason, training facilitators should share their contact information with training participants so they can backstop and assist on technical matters when needed.

Organization of this book

This book is organized as follows: After presenting a general introduction on the training format and style, and materials needed for a one-day training, five independent learning sessions are presented. Each session covers a different topic, including:

1. Introduction, training objectives, and participant pre-test
2. Weeds and integrated weed management practices
3. Sprayers, spray technology and sprayer maintenance
4. Calibration of the sprayer
5. Practical exercise on spraying technique
6. Review of key points/messages, participant post-test, and close of the training.

Instructions are then given for the individuals facilitating trainings on how to implement each session. This includes a review of the learning objectives, key messages, required materials, and step-by-step instructions on how to conduct the training session from start to finish, while working to encourage experiential learning as articulated above. Most sessions all include a component during which the facilitator is expected to give a brief presentation on the topic. Presentations are intended to be discussion oriented, so the facilitator should allow time for participants to ask questions, and in turn elicit questions and feedback if few participants are speaking.

Flip chart materials are provided to guide the technical content for each of these presentations. Facilitators should simply follow the flip charts and use the material presented to initiate discussion and assure that all technical points are covered. Care should be taken to allow all participants to speak, and to make space for underrepresented participants, specifically women, to speak and ask questions.

The pages of this book can be printed out on large poster sized paper and used for the flip charts. Flip chart sessions should be conducted in the field and not in a classroom. The same flip charts are also intended to be printed on normal size paper, stapled together, and provided as handouts and reference material for participants.

Lastly, trainings are to begin with a pre-test of participants' knowledge, and end with a posttest of their knowledge after the training. The change in participants' scores gives an indication of their progress in learning. Ready-made pre- and post-test exam sheets are included within this book. Simply print them on regular size paper for use.

Training aims and objectives: Integrated Weed Management

This training is aimed at improving farmers' and agricultural machinery service providers' awareness and knowledge about weed management and associated machinery practices, and to improve their skill so that they can ensure safe, effective, economic and environment friendly weed management. Effective weed management is very important if service providers are to establish fields using conservation agriculture, strip tillage, or direct seeding in the case of rice. This module is designed to cover the major principles needed to manage weeds in a safe, productive, and integrated way.

By the end of the training, participants should be able to:

- Understand and explain the importance of weed management.
- Describe the implications and mechanisms of crop-weed competition.
- Be able to explain the difference between broadleaf species, sedges and grasses, and their implications for weed management.
- Explain the difference in weed management through manual, mechanical, cultural and chemical methods.
- Understand how herbicides work with different types of weeds, and clarify different types of herbicides.
- Demonstrate an ability to apply herbicides in a safe and environmentally sound way.
- Differentiate between sprayer nozzle and boom types.
- Calibrate the sprayers properly.
- Understand when to apply herbicides, and at what rate for effective, economic and environmentally safe weed control.
- Demonstrate knowledge on herbicide resistance and how to develop a herbicide resistance management program.

Who is this training designed for?

Rural agricultural service providers and/or farmers interested in understanding and/or practicing improved weed management, conservation agriculture or direct seeded rice, and local operators who usually spray pesticides in farmers' fields. Note that this module

builds on the previous 'Principles of conservation agriculture' module (Book I in this series). We recommend that participants taking the Integrated Weed Management training complete the 1-day CA module before enrolling in the current module. In addition, this module provides advice that is important for the management of weeds in directly sown rice, a topic covered in the next module on two-wheel tractor driven seed and fertilizer drills (Book III). Completion of the IWM sessions is therefore pre-requisite to moving on to this material.

Key considerations for training

Key considerations for training planning, preparation and organization of training events are given below. The facilitator(s) as well as training coordinator should read each section carefully to ensure effective and efficient implementation of the training. The information presented here is generalizable for each training in this series of books. More specific information that pertains to individual trainings is also presented at the beginning of each module. Be sure that you also review this material.

Participants

The number of participants per batch should be limited to a maximum of around 10-15 people. Ideally, it is good to have at least one machine, sprayer, or piece of equipment per three to five participants so the opportunity for hands-on learning is increased. Ideally, at least 25% of the participants should be female. Trainees should be targeted who have leadership capability, at least primary level of education, ideally business experience, and with capability to work outside the household and run a rural business. These points are important as these types of participants may increase the potential that they transfer their knowledge to other farmers or service providers. Participants should be contacted well ahead of the date (at least one week) of training to allow them to prepare for the training.

Venue

The training venue should be selected carefully. There should be a covered outdoor area, or similar facility having sufficient light, air, and adequate space for the number of participants listed with each session, and a large bare field/crop land (with adequate space to experiment with equipment). This outdoor area should be no more than a 5-minute walk away from the place where participants will meet. The space should be free from outside distractions.

Training aids

Please review the detailed list of training aids listed at the beginning of each module and assure that all required materials are available.

Facilitator(s)

Experienced field technicians and/or extension agents should be selected to facilitate the training, following their passing a training course to familiarize them with the principles of experimental learning and each training module and session set.

Facilitators' preparation

Well ahead of starting the training, facilitator(s) should go through the 'the respective module of interest and also respective topic(s) and practice the implementation techniques as per allocated time. Each session contains different topics, implementation techniques and time allocation. So facilitators should have to read them minutely and practice them following the power point presentation/flip charts for timely and lively presentation.

Date of training

The date of the training should be decided following discussion and agreement with trainees to ensure their participation (preferably during their weekly day off to avoid any financial loss to their business).

Registration

Participants should reach the training venue on time. Immediate after arrival at the venue, each participant should register their names and then take seat in the classroom. Participant registration should be completed before beginning of the training session. No registration should be made once training session begins.

Group formation

Before starting the pre-evaluation exercises that begin each training module, divide participants into three small groups (i.e. 5 participants per group, however, number of groups or number of participants per group may vary depending on total number of participants and availability of machinery). Working in smaller groups assures a more action-oriented, hands-on approach to learning. Generally, four to five people should be assigned to work on each available machine. Set up any seating arrangements so these small groups can sit with one another. Participants will take part in discussions, questions and answer sessions, demonstrations, exercises, etc. in this small group throughout all sessions. Do not set up seats in classroom style. Circular seating should always be used.

Participatory, experiential, and hands-on learning

The training approach should be participatory, with emphasis on hands-on and experiential learning. The facilitator should utilize techniques that aim to get participants interested and involved in the training, for example question and answer sessions, experience sharing, group exercises, group discussions, group presentations, etc.

Effective and enjoyable training

The training should be facilitated in such a way that the trainees feel it useful/valuable (rather than waste of their time). To achieve this goal, the facilitator should work to assure that the training is enjoyable (use of fun games, quizzes, sing along, or other techniques to get trainees excited). One-way lecture formats are not acceptable and are discouraged.

Turn off mobile phones

Use of mobile phones causes distractions and reduces the effectiveness of the learning experience. All participants, including the training coordinator and facilitator should keep their mobile phones switched off during the training session.

Participants evaluation

A pre-evaluation test before starting the training session and a postevaluation test at the end of all training sessions is important and required to judge effective learning. Pre- and post-evaluation questionnaires are attached the respective annex.

Course preparation, duration, materials, and setting

The course is designed for a one-day approximately 7 hours including demonstration and practical exercise, and excluding lunch and breaks. This is therefore an intensive course, which should be held in the field, and not in a classroom. Training facilitators can decide on the best time to take tea and lunch breaks, etc. Note that these times are not included in the time estimates above, and hence should be accounted for in planning the training. Times should be kept flexible depending on the needs of the participants. Some sessions may be faster than reported above, or slower. This is why it is important to remain flexible.

The content is divided into five instructional sessions as follows:

Session	Topic	Approximate duration (minutes)
1	Introduction, training objectives, and pre-test	60
2	Weeds and integrated weed management	75
3	Sprayers, spray technology and sprayer maintenance	45
4	Practical calibration	90
5	Practical exercise on spraying techniques	90
6	Review of key points and messages, post-test, and close of the training	60

Planning and preparation for the training

Please review the 'planning and preparation for training events' section at the front of this book. Note that you may wish to establish demonstration learning field plots before this training (detailed below in different sessions), so advanced preparation of several weeks is required. In addition to the items listed there, prepare for this training by considering the following:

Training venue

Provide adequate space outside with cover from the sun for at most 10-15 participants, and a bare field/crop land (with weeds and adequate space for operating at least two sprayers for herbicide application exercises) nearby for practical session. The venue should be free from outside distractions.

Required training aids

- ✓ Demonstrations plot with and without weed management, preferably with under strip tillage or direct seeded rice, or other machine planted crop establishment methods. Demo plots should be established well ahead of the training so that it becomes ready to serve the training purpose on time.
- ✓ At least one print out of the pre- and post-tests for each participant (see Annexes).
- ✓ Notebook and pencils for each participant.
- ✓ At least one copy of "Common herbicides" for each participant (see Annexes).
- ✓ Pre- and post-tests for each participant.
- ✓ Pencils and spare paper/notebooks for each participant.
- ✓ Printed flip charts on integrated weed management (See Flip Charts).
- ✓ White board or blank flip-chart paper and dry erase markers.
- ✓ Handouts for each participant in the form of printed and stapled A4 sized paper versions of the flip charts.
- ✓ Flip chart stand, white board and stand, white board pens.
- ✓ Multi-colored index cards.
- ✓ Hand weeding tools (like hand hoe or niranee, khurpi, etc.), mechanical weeders, including manual operated and motorized (if available).

- ✓ If possible, one successful farmer familiar with IWM principles and safe and environmentally sound herbicide use.
 - ✓ Several units of different types of backpack pump sprayers (manual operated traditional backpack, battery operated, motorized sprayers) for demonstration (if available, if not, simple pump sprayers will do). In addition, Three to four knapsack pump sprayers (manual or battery operated) for herbicide application (one for the training facilitator and then one each for each group).
 - ✓ Measuring beaker to measure water (250, 500, 1000 ML capacities are ideal).
 - ✓ 3-4 water buckets of at least 10 L each
 - ✓ Flexible measuring tape (at least 20 m length)
 - ✓ At least 12 empty plastic bottles
 - ✓ 2 rolls of duct tape or electrical tape
 - ✓ 1 kg of urea
- ✓ Spray nozzles: 3-4 sets of different types of nozzles (flat fan type, even flat fan type, cone type, and flood jet/cut type, if available) to demonstrate how these nozzles differ in spray pattern. Make sure they come with strainers.
 - ✓ Spray booms: 3-4 sets of multiple nozzle booms (e.g. three nozzle booms) fitted with flat fan nozzles, if available. One single nozzle boom is also needed.
 - ✓ About 1L each of pre-emergent and post-emergent herbicides (select the active ingredient most appropriate for your region, or for the weeds to be controlled).
 - ✓ Protective clothing (at least 3 sets) for herbicide application, including goggles, a mask to cover the face, protective poly-ethylene coat that covers the head and arms, gloves, protective polyethylene trousers, and gumboots, as shown below:

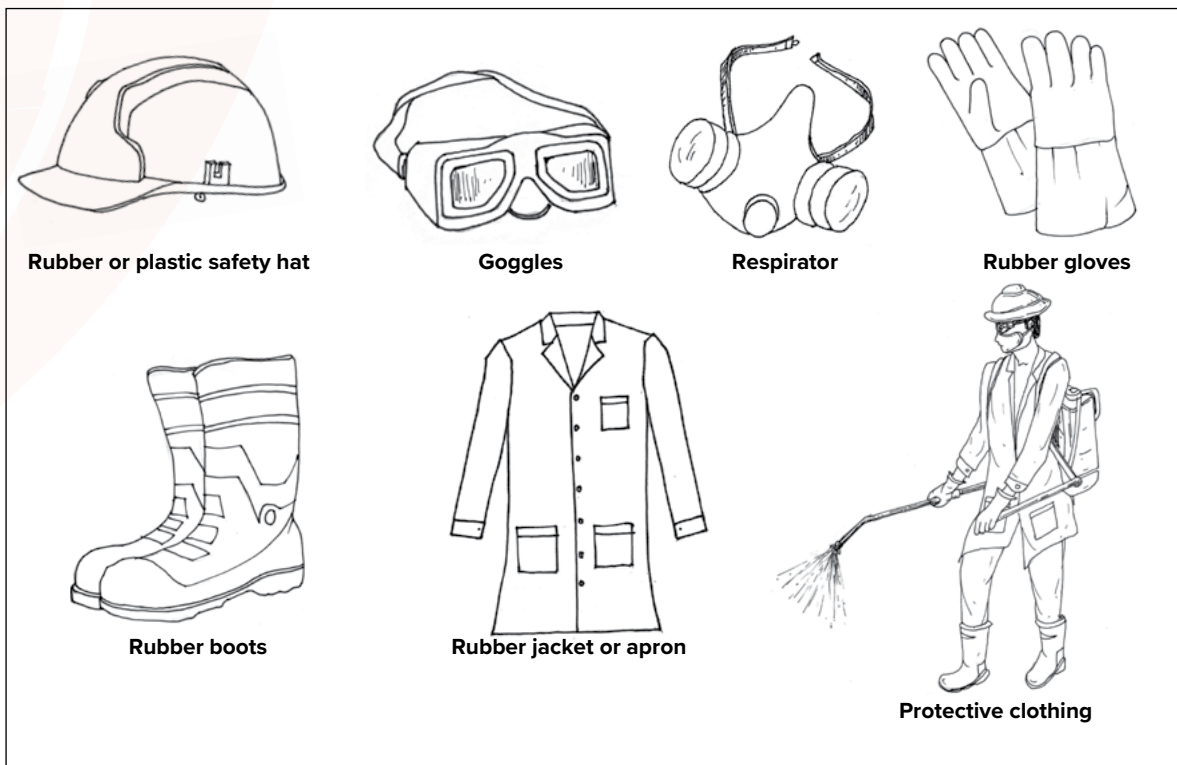

Session 1

Introduction and training objectives

Learning objectives

At the end of this introductory session, participants should be able to:

- Give the names of trainers and other participants.
- State the anticipated objectives and content of the training.
- Understand training guidelines for learning and cooperation, and assess their own knowledge level regarding the contents of the training.

Key messages to convey to participants throughout the introductory session

- This training is composed of six sessions and will take about 7 hours excluding lunch, tea or other breaks. Please be patient but there is a lot of material to complete.
- This is a participatory and fun training, and both trainers and trainees will learn from each other.
- The training is mostly hands-on. Participants should learn by working with the IWM principles and equipment themselves rather than just listening. Active participation is best.
- Participants should be attentive during the training and participate either individually or in groups for each task/assignment/exercise given to them.
- All participants as well as facilitators should keep their mobile phone switched-off, or on silent, and if they receive an urgent call, excuse themselves from the group to go elsewhere to answer the call.

How to conduct the introduction

Assemble training participants and make use of the flip charts (See Session 1: Introduction to integrated weed management) designed to introduce the training.

Step 1 – Form groups (15 minutes)

Most adults learn best when they can work in groups. Participants in a small group can interact and can share ideas with each other, which allows peer-to-peer learning, and can stimulate more entertaining and rich learning experiences.

An ideal size is 10-15 participants for the entire training, which will be divided into smaller groups. Divide the participants into groups of four or five people by requesting to call off numbers from 1, 2, 3, 4, 5, etc. (you do this because people generally like to sit with the people they already know best).



Next, rearrange seating so people with the same number form new groups. Ask members of each group to sit together by rearranging their seats. Also ask them to select a group leader and choose a fun name for their group. It is helpful if the group leader can read and write. Also, try to be sure that someone in each group is competent in basic mathematics and calculations. This will be important later on when learning about machine calibration and business models.

Ask each group to find five things they have in common, with every other person in the group, and that have nothing to do with work (please no body parts as we all have legs, and we all have arms! Also, no clothing too, as we all wear clothes. Focus on more interesting commonalities). This helps the group explore shared interests more broadly.

Request the group leaders to take notes and be ready to read their list to the whole group at the end of the session. This should generate a lot of laughter and fun, and discussion, while encouraging the groups to think more like a team.

Step 2 – What are participants' expectations? (10 minutes)

This is one of the most effective tools for breaking the ice, and getting new group participants to get to know each other. Each group member is an important source of knowledge. Each participant also has his or her own style of thinking and learning. For this reason, understanding the participants' expectations of the training module is important for effective learning. It will also help the training coordinator and facilitators be better equipped to deliver a successful learning experience through the training.

Use the icebreaker "Expectation" at the beginning of the day to get feedback from each participant regarding what they expect and also want to get out of the training.

During the introduction of the training module, when it is time for participants to introduce themselves following group formation, the training coordinator or facilitator will explain that participants' expectations are very important, and understanding them will be crucial for assuring quality outcomes from the training. These expectations can later be compared with the module outline, and modifications and changes can be made where necessary.

The training coordinator should ask each of the groups to:

- Introduce themselves individually
- Share their expectations of the training course (provided as a summary from the group leader after 2-3 minutes of discussion)

Here's an example:

"Hi, my name is Rahim. Our group is expecting to get rid of very nasty weeds in rice without having to spend hours pulling them by hand. Will we learn how to do that?"

At the end of the training, the training coordinator should review the list of expectations the groups made, and discuss/explain points if not covered in the course and explain whether or not, and why, if not, their expectations won't be covered in the course.

Step 3 – Introducing the training (10 minutes)

The training coordinator will then present using flip chart Session 1: '*Integrated Weed Management – Introduction and training objectives*' a brief overview on the training course, the methods of training, and rules and responsibilities to be followed by the participants. Allow time to ask questions, and for the participants to ask any clarifying questions.

Step 4 – Pre-test evaluation (25 minutes)

Distribute the 'pre-evaluation questionnaires' (see Annex 1) among each participant and allow 20 or so minutes to answer the questions. If needed, the facilitator will help less literate participants to understand and answer the questions. The test can also be printed and placed on flip chart paper. Collect the pre-evaluations for later comparison with the post-test evaluations at the conclusion of the training. They should be corrected during the course of the day, prior to the closing session.

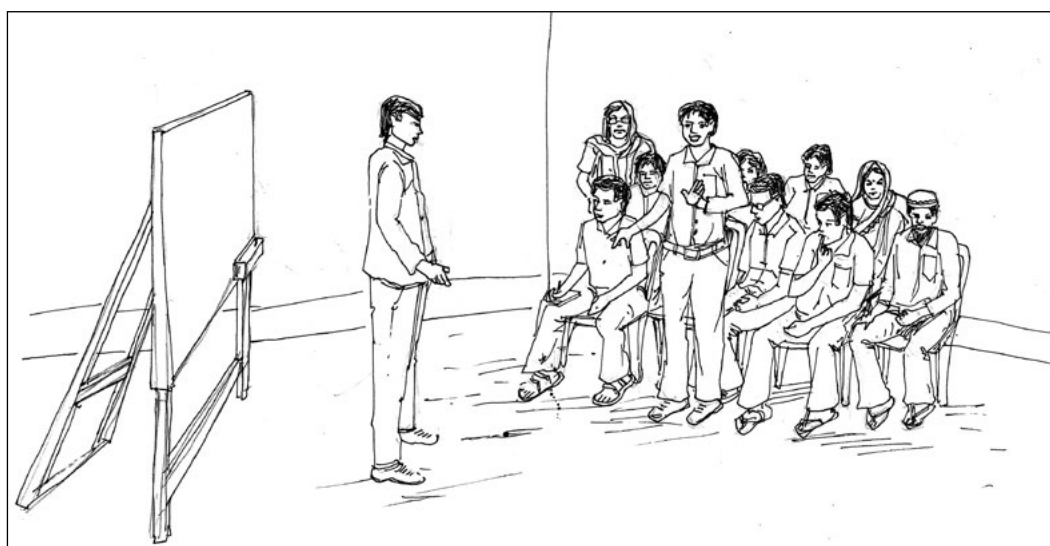

Session 2

Weeds and integrated weed management

Learning Learning objectives

At the end of this session, participants should be able to:

- Identify different types of weeds including broadleaves, sedges and grasses.
- Articulate the principles of crop-weed competition.
- Understand different types of weed management practices including manual, mechanical, cultural and chemical management.
- Select the appropriate herbicide considering type of weed and stage of weed control i.e. pre-plant, pre- or post-emergence.

Key messages to convey to participants throughout the this session

1. Weeds are mainly of three types, broadleaves, sedges and grasses.
2. Weeds compete with crops for nutrients, water, and light.
3. Weeds can be controlled manually (hand weeding), mechanically (using weeders or other implements when crops are line sown), through cultural practices (use of weed competitive crop cultivars, stale seed beds, mulching, crop rotation) and /or chemically (using herbicides).
4. Chemical management of weeds can be done at three stages: Pre-plant (burn-down), pre-emergence and post-emergence.
5. Pre-plant burn-down herbicides are non-selective and are applied before you sow the crop to kill the existing weeds. These herbicides are especially important under zero-till/conservation agriculture based systems.
6. Pre-emergence herbicides are applied after crop seeding but prior to emergence of weeds, 1-3 days after seeding or transplanting, by ensuring adequate moisture at the time of spray.
7. Post-emergent herbicides are applied after the crop and weeds are emerged, generally at 3-4 leaf stage.

8. Select the appropriate herbicides for specific crop considering type of weed that is a problem in the field (broadleaf, sedge or grass) and stage of weed control (i.e. pre-plant, pre-emergence or post-emergence).

How to conduct the weeds and integrated weed management session

For this session, you will need the flip chart "Session 2: Weeds and integrated weed management", printed copies of the flip chart as a handout for each participant, copies of Annex 1 "Common herbicides", a crop field or demonstration plots where different types of weeds can be observed, samples of pre-plant, pre- and post-emergent herbicides to control different types of weeds.

Step 1 – Generate reflection and discussion (10 minutes)

Initiate the session at field beside a demonstration plot or field with weeds. The facilitator should ask the participants:

- *In what ways do weeds reduce crop growth?*
- *What are the weeds commonly found in your crop fields?*
- *How do you control weeds?*

Allow one or two participants to answer the question. The facilitator should note important points on poster paper or white board for later discussion.

Step 2 – Use flip charts to generate discussion and learning (45 minutes)

Next make use of the flip chart to explain integrated weed management to the participants. You will need the "Session 2: Weed and integrated weed management" flip chart. Summarize this material verbally and pause to ask questions at the end of each flip chart page.

Note that the flip chart presents weeds and gives their scientific species name. These names can be changed to local names in the language in which the training is to be conducted to improve participant learning.

Here are the main messages to convey:

1. Weeds compete with crops for light, water, and nutrients.
2. Control weeds before they begin to severely compete with crops, and assure they have been removed or killed before they set seed.
3. The three classes of weeds include broadleaves, sedges, and grasses. Knowing which group the weeds in your field belong to is important for selecting the right herbicide. It is important to be able to tell the difference between these classes quickly and by eye.
4. Integrated weed management makes use of different forms of weed control. This improves the management of weeds and reduces the development of herbicide resistance.
5. Cultural management methods are easy to apply and should be used to control weeds before considering use of herbicides. Cultural control methods are also part of best agronomic management practices.
6. Manual and mechanical weed management can be effective to remove perennial and noxious weeds. Mechanical weeders are available that can be effective for rice, though for perennial weeds, additional hand weeding may be needed to remove the roots of the weeds as they cause re-growth.
7. Herbicides should only be used along side cultural and mechanical control options.

8. Herbicides can cause weeds to become resistant to chemical control. Monitor closely for herbicide resistant weeds and be ready to change weed control products as needed.
9. The three major kinds of herbicides are pre-plant, pre-emergence, and post-emergent herbicides.

At the end of each flip chart page, ask the participants if they understand or have questions. Always take time to answer their questions.

Annex 1, 'Common herbicides' can also be handed out during this session. This Annex provides a table and critical information on the use of different herbicide types that can be referred to after the training.

Step 3 – Weed classification discovery learning exercise (20 minutes)

Supply index cards to each group (supply three cards each with the specific weed type i.e. broadleaf, sedge, or grass) and ask them to collect at least three different types of weeds that belong to that particular type from the nearby crop field/demonstration plot. Give groups about 10 minutes to complete this task.

When they return to the area in which the flip chart was displayed, ask them to display out the weeds below the cards indicating if they are broadleaves, sedges, or grasses. Allow up to ten minutes more for groups to do this, and then ask each group to review the other groups' work to determine if weeds are correctly categorized.

Session 3

Sprayers, spray technology, and sprayer maintenance

Learning objectives

At the end of this session, participants should be able to:

- Select an appropriate sprayer for spraying herbicide.
- Identify different parts of a sprayer and understand their functions.
- Identify and understand the characteristics of different types of nozzles and booms.
- Understand and explain key components of accurate herbicide application.
- Ensure proper maintenance and storage of the sprayer.

Key messages to convey to participants throughout the this session

1. Different types of sprayers such include knapsack sprayers, foot sprayer/pedal pump sprayer, traction pneumatic sprayer, tractor mounted sprayers and Aerial sprayers. Knapsack sprayers are most common for small farmers in the tropics.
2. Knapsack sprayers are most commonly used for spraying herbicides in field crops. Three types of knapsack sprayers are often available in the market, including hydraulic, manual pneumatic and motorized/battery pneumatic sprayers.

How to conduct the Sprayers, spray technology, and sprayer maintenance session

For this session, you will need the flip chart "Session 3 – Sprayers, spray technology, and sprayer maintenance", printed copies of the flip chart as

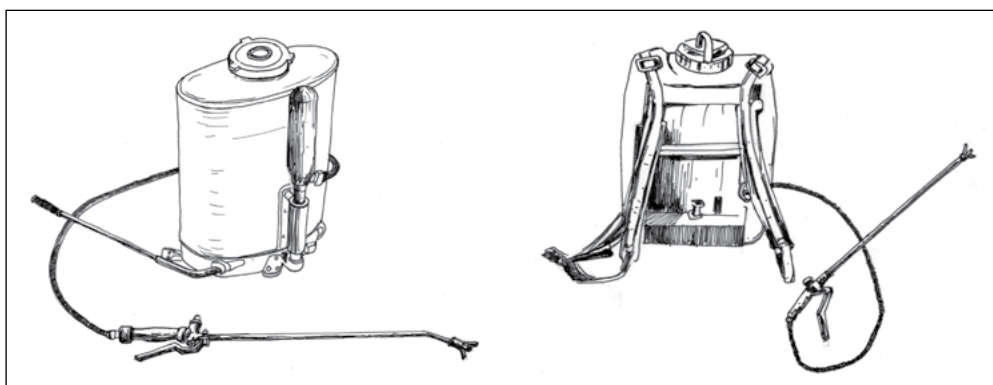

Above: Knapsack sprayers with a single nozzle boom

a handout for each participant, different types of knapsack sprayers, i.e. hydraulic, manual pneumatic, and motorized and battery pneumatic (if available), single and multiple nozzle booms, different nozzle types, and a shield or hood.

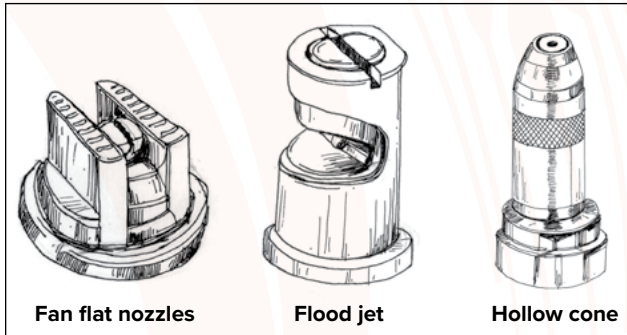

Step 1 – Generate reflection and discussion (15 minutes)

The facilitator will initiate the session through exploring participants’ experience about spraying herbicide or insecticide. He/she will ask the following questions one by one after answering to previous one is completed:

- Which type of sprayers available in your area?
- Which sprayer is suitable for spraying herbicide?
- Which type of nozzles is used for applying herbicides and why?
- What types of booms are available in your area?
- How you ensure accurate application of any herbicide or insecticide?

Allow 1-2 participants to answer each question. Facilitator should note points important for following discussions on the white board.

Step 2 – Use flip charts to generate discussion and learning (30 minutes)

Using the flip charts and the sprayers and parts that have been brought to demonstrate, review these key items:

- Different types of sprayers
- Sprayers suitable for herbicides
- Different parts of a knapsack sprayer
- Nozzle and boom types and applications
- Spray swath
- Pressure regulation
- Avoiding spray drift
- Maintenance and storage of sprayers

During the flip chart session, pass the sprayers and nozzle parts around the groups for inspection. Allow time for questions and discussion after reviewing each flip chart page, and make sure to complete the session by reviewing the key points and asking participants if they have questions.

Session 4

Practical calibration

Learning objectives

At the end of this session, participants should be able to:

- Understand and explain factors affecting calibration of a sprayer.
- Clarify the difference between granular and liquid herbicides.
- Calculate the required water/spray volumes.
- Calculate the amount of herbicide per tank.
- Calibrate a sprayer appropriately following necessary steps and calculations.
- Maintain personal and environmental safety while mixing, preparing and spraying herbicide.

Key messages to convey to participants throughout the this session

1. Calibration is the process of determining the sprayer output for a known area.
2. Field size, droplet size, nozzle size and spacing, nozzle capacity, speed and pressure all influence herbicide effectiveness.
3. Wear mask, gloves, coveralls, hat, goggles, gumboots, etc. as a safety measure before mixing and preparing, and applying herbicides.
4. Select the appropriate sprayer and nozzles.
5. Make sure the sprayer is at the correct pressure, and that you hold the spray nozzles (called a boom) at the right height.
6. Calibrate the sprayer using a field for testing before actual use in the field.
7. Re-calibrate if pressure, nozzles, or speed is changed.

How to conduct the practical calibration session

For this training session, you will need the following resources and materials:

- The flip chart "Session 4 – Practical calibration"
- Printed copies of the flip chart as a handout for each participant
- Blank poster paper/white board, marker pen
- A plot of least 33 m x 3 m in size
- Protective clothing (at least 3 sets or one per group) for herbicide application, including goggles, a mask to cover the face, protective poly-ethylene coat that covers the head and arms, gloves, protective polyethylene trousers, and gumboots
- Four knapsack sprayers (ideally around 15 L capacity)
- Measuring beakers to measure water (250, 500, 1000 ML capacities)
- At least four flat fan/flood jet types, ideally with multiple booms
- Several flat fan nozzles (for four knapsack sprayer and if using 3 nozzle booms, 12 flat fan nozzles would be needed)
- At least 12 empty plastic bottles
- Duct or electrical tape to attach bottles to nozzles and booms
- 1 kg of urea
- Measuring tape
- Appropriate herbicide for the weeds present in the field (preferably pre-plant or preemergent)

Step 1 – Raising participant’s awareness (10 minutes)

Initiate the session by exploring participants’ experience about calibrating sprayers.

Why should you calibrate the sprayer before spraying herbicide or insecticide?
How do you calibrate the sprayer?

Allow 1-2 participants to answer each question. Facilitator should note points important for following discussions on the white board or blank flip chart paper.

Step 2 – Flip chart to generate discussion and learning on how to calibrate a sprayer (30 minutes)

This session is to be held in the field, using flip charts near a plot on which the sprayers can be calibrated.

Note that flip charts make use of metric units like liters, m², and hectares. To improve participants’ learning, these should be converted to local units and explained on the white board. Assure that the conversion from area sizes to local units is clear to each participant. We suggest changing the units before the training and testing the calibration calculations in advance of the training to assure they are correct.

Key messages to convey to participants throughout the this session include:

- Always wear mask, gloves, coveralls, hat, goggles, gumboots, etc. as a safety measure before mixing and preparing, and applying herbicides
- Granular herbicides are broadcast; liquid fertilizers are sprayed and require more careful calibration
- Select the appropriate sprayer and nozzles
- Make sure the sprayer is at the correct pressure, and that you hold the spray nozzles (called a boom) at the right height
- Calibrate the sprayer using a field for testing
- Calculate water volume per field area
- Calculate tank number
- Calculate herbicide rate per tank
- Add surfactants to improve herbicide effectiveness
- Re-calibrate if pressure, nozzles, or speed is changed

Assure time at the end of each flip chart page to ask questions to participants, or allow them to ask clarifying questions.

Step 3 – Hands on calibration exercise and experiential learning (50 minutes)

If an experienced spray operator is available, first ask them to demonstrate the procedure of practical calibration focusing on following points:

- Select test area: Select an area of 33 m × 3 m
- Select the appropriate sprayer and nozzle: knapsack sprayer of 15 litre capacity and flat fan or flood jet type nozzle, and associated boom
- Calculation of water/spray volume
- Adjusting the sprayer calibration
- Calculation and addition of herbicide per tank
- Calculation and addition surfactant per tank

Following the demonstration and any discussion, ask each group to calibrate a sprayer themselves. Before doing this, assure they have put on protective clothing correctly.

Demonstrate how to put on the protective clothing gumboot, mask, gloves, coveralls, hat, goggles – it is best to do this by asking one participant to put on all the equipment and to then ask the participants to critique and point out if any part has not been put on correctly, for example if the pants are tucked into the boots, rather than the outside, so spray can roll down the pants and off the boots without being trapped in them, and so-on. The experienced operator can assist the training facilitators with helping the participants, and to assure that calibration has been done correctly.

Session 5

Practical exercise on spraying techniques

Learning objectives

At the end of this session, participants should be able to:

- Maintain personal safety during spraying herbicide (Prepare themselves with protective clothing i.e. mask, gloves, coveralls, hat, goggles, gumboots, etc.)
- Prepare the required spray volume with appropriate herbicide
- Spray the herbicide accurately maintaining adequate speed, pressure and boom height
- Demonstrate awareness that herbicides are poison and therefore must be handled carefully.
- Ensure environmentally sound and personally safe herbicide application

Key messages to convey to participants throughout the this session

- Wear protective clothing when mixing, spraying, and disposing of herbicides
- Use the right spray boom height and direction
- Walk the right path when spraying in the field
- Do not swing the spray boom
- Do not spray herbicides when it is windy, or when people or animals are nearby
- Properly dispose of herbicide bottles
- Always store herbicides in locked boxes away from children

How to conduct the sprayer practical exercise session

For this training session, you will need the following resources and materials:

- The flip chart "Session 5 – Practical exercise on spraying techniques"
- Printed copies of the flip chart as a handout for each participant
- A weedy and weed free plot (on which weeds were controlled prior to the training)
- Blank poster paper/white board, marker pen
- A weedy field
- Protective clothing (at least 3 sets) for herbicide application, including goggles, a mask to cover the face, protective poly-ethylene coat that covers the head and arms, gloves, protective polyethylene trousers, and gumboots
- Four Backpack/Knapsack sprayers calibrated and prepared in the previous session (ideally around 15 L capacity)

Step 1 – Discussion on herbicide spraying (5 minutes)

Initiate the session by exploring participants' experience about calibrating sprayers.

- How do you use a sprayer in a way that is not wasteful?
- Under what conditions is it safe to spray?

Allow 1-2 participants to answer each question. Facilitators should note points important for following discussions on the white board or blank flip chart paper for later discussion and review.

Step 2 – Use the flip charts to generate discussion on spraying techniques (20 minutes)

Using the flip chart “Practical exercise on spraying techniques”, review the key points of the training. Allow time at the end of each flip chart page to generate discussion and clarify that participants understand the material that has been presented.

Step 3 – Prepare for the spraying exercise (20 minutes)

If you are not already outside in the field near the plots that have had weed control and no weed control, move the training participants to the field. Next, the facilitator or an experienced user of herbicides will demonstrate the following points in practical field exercise:

- Point out and discuss the effectiveness of weed control in the weed-free compared to weedy plot, and explain that if weeds are not well controlled, then they can become a serious problem
- Review how to put on protective clothing (as discussed in the previous session) by asking 3-4 people (one from each group) to put on protective clothing. Next, have other group members critique if they did it correctly.

Step 4 – Hands on spraying practical exercise (45 minutes)

Next, divide the participants into their groups, and ask each of them to do each of the following things listed below. But first, the facilitator or experienced herbicide applicator should demonstrate the following techniques. Participants should watch and learn from the experienced service provider who demonstrates each of the steps below:

1. Select the appropriate sprayer and nozzle for the weeds in the field
2. Select the appropriate pre- or post-emergent herbicide depending on the types of weeds present and stage of application
3. Calibrate if necessary, and measuring the herbicide and water, safely mixing them while wearing protective clothing
4. Use of surfactants to improve herbicide effectiveness
5. Use appropriate boom height, and sprayer pressure (refer to the flip chart)
6. Checking and assuring correct sprayer pressure
7. Spray the field using the correct walking path and speed
8. Cleaning the tank after spraying
9. Cleaning the clogged nozzle safely and effectively

Session 6

Review, post-test, and closing

Learning objectives

At the end of this session, participants should be able to:

- Demonstrate sufficient knowledge of integrated weed management from the previous sessions

Materials required

- The flip chart "Review of key points and messages"
- Print outs of the post test
- Training or project logbook (if any)
- Pencils for participants
- Awards (if any)

How to conduct the review, post-test, and closing of the training

Step 1 – Review integrated weed management material (20 minutes)

First review the flip chart. You will notice that the flip chart has questions. This is because the facilitator should ask participants these review questions and help them answer them, and correct any wrong answers.

Step 2 – Conduct the post-test (30 minutes)

Distribute the post-tests to participants. Allow them to answer the questions in about 15 minutes. Calculate their scores, and check them compared to their pre-test. Give both pre- and post-tests back to the participants for review. Also record each participant's score in a training or project logbook. If any errors are common, take time to discuss them with participants and to correct any misconceptions before closing the training.

Step 2 – Close the training (10 minutes)

Distribute any awards for best participant or group, handout certificates; assure participants have contact information for trainers, and handouts. Close the training.



Flipcharts and handout materials



Session 1

Integrated weed management, introduction and training objectives

Integrated weed management
one-day training flipchart



Sessions for today's training

- 1. Introduction and pre-test**
- 2. Weeds and integrated weed management**
- 3. Sprayers, spray technology and sprayer maintenance**
- 4. Practical calibration**
- 5. Practical exercise on spraying**
- 6. Review of key points and post-test**



What kind of training is this?

- ◆ This is a participatory training
 - ◆ Please ask questions and speak!
- ◆ Learn by experience: we encourage you to try calibrating and spraying yourself

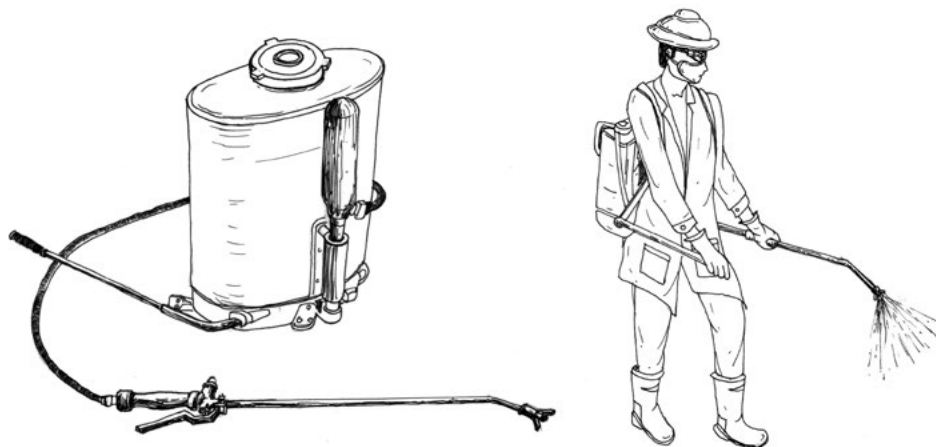

- ◆ Discuss with your group members to improve your learning
- ◆ We encourage you to speak when and ask questions. This will improve your learning.

Please enjoy this training!

- ◆ Feel free to ask questions and to contribute your knowledge!
- ◆ Make sure you get time to practice calibration of a sprayer and spraying or application of herbicide yourself!
- ◆ Have fun!



Session 2

Different types of weeds and weed management practices

Integrated weed management
one-day training flipchart



Why are weeds a problem?

- ◆ Weeds compete with crops for water, soil nutrients, and light.
 - ◆ Weeds should be removed or killed before they compete or flower and make seeds.

What kinds of weeds are there?

- ◆ Annual weeds grow quickly and set seed 1 or more times a season.
 - ◆ Bi-annual weeds take two or more seasons or years to flower and seed.
- ◆ Perennial weeds grow throughout the year. If you pull them up, many will regrow from their roots in the soil.

Common weeds found during the *kharif* season and in rice

Grasses (with hollow stems that look like
this if you break them in half: O)



***Echinochloa
crusgalli***
(annual)



***Echinochloa
colona***
(annual)



***Leptochloa
chinensis***
(annual)

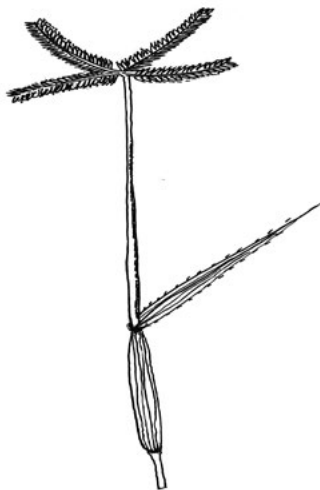

***Dactyloctenium
aegyptium***
(annual)



Eleusine indica
(annual)

Common weeds found during the *kharif* season and in rice

Broadleaves (with wide leaves)



Eclipta Prostrata
(annual)



Sphenochlea zeylanica
(annual)

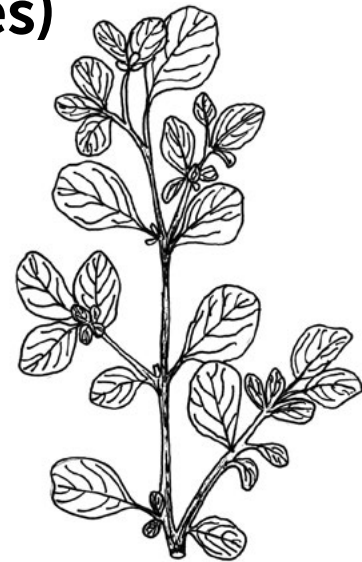

Trianthema portulacastrum
(annual)



Commelina benghalensis L.
(perennial in the tropics)



Centaurea diffusa (annual or biannual)



Ludwigia spp.
(annual, biannual, perennial)

Common weeds found during the *kharif* season and in rice

Broadleaves (with wide, pointed leaves)



Monochoria vaginalis
(Burm f.)* (perennial)

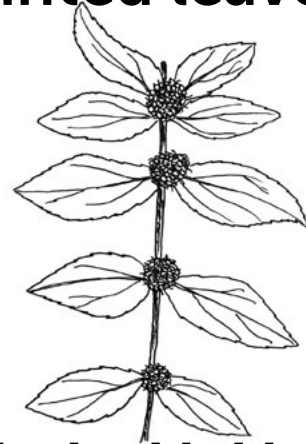

Euphorbia hirta
(annual)

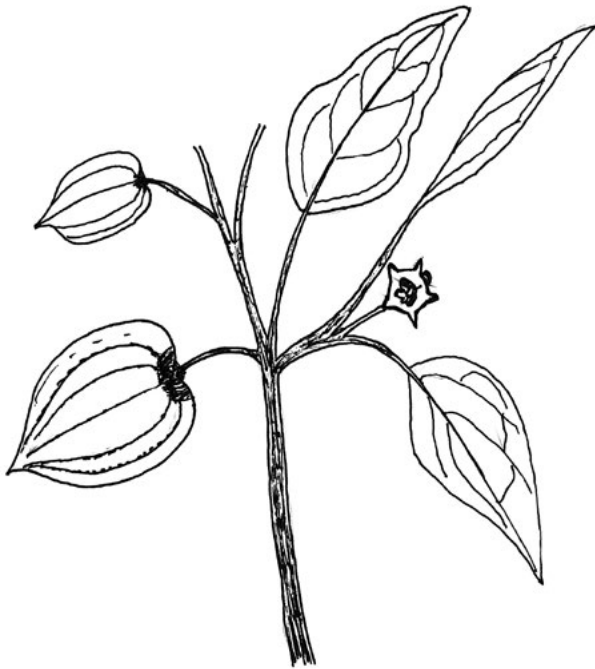

Physalis minima
(annual, right)



Paspalum distichum**
(perennial)

* Germinates from the soil. Not to be confused with water hyacinth (*Eichhornia crassipes* (Mart.) Solms)

** Also appears in rabi season upland crops

Common weeds found during the *kharif* season and in rice

Sedges (with hollow stems that look like
this if you break them in half: Δ)



Cyperus difformis
(annual and
perennial)



Cyperus iria
(annual)



Cyperus rotundus
(perennial)

***Fimbristylis
miliacea***
(annual and
perennial, right)



Common weeds found during the *rabi* season and in crops like wheat, maize, and legumes

Grasses (with hollow stems that look like this if you break them in half: O)



Phalaris minor
(annual)



Poa annua
(annual)



Avena ludoviciana
(annual)



Cynodon dactylon
(annual and perennial)

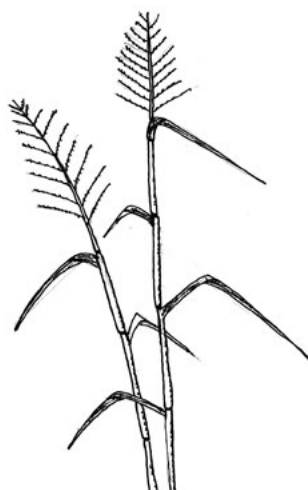

Leptochloa chinensis
(annual)*

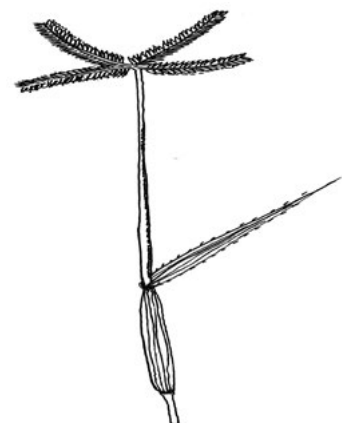

Dactyloctenium aegyptium
(annual)*

* Predominantly weeds of kharif maize

Common weeds found during the *rabi* season and in crops like wheat, maize, and legumes

Broadleaves (with wide, pointed leaves)



Chenopodium album
(annual)



Anagalis arvensis
(annual or perennial)

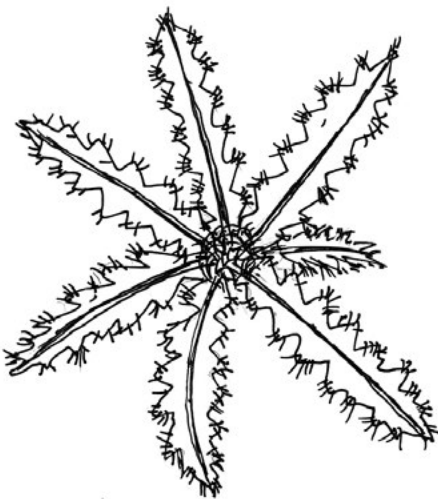

Cirsium arvense
(perennial)



Convolvulus arvensis
(perennial)

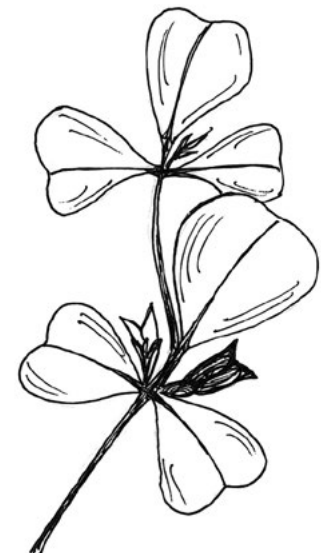

Medicago denticulate
(annual)

Common weeds found during the *rabi* season and in crops like wheat, maize, and legumes

Broadleaves (with wide, pointed leaves)



**Coronopus
didymus**
(annual)



**Solanum
nigrum**
(annual)



**Amaranthus
viridis**
(annual)

Melilotus alba
(annual, right)



What is integrated weed management?

- ◆ **Integrated weed management is the use of several different methods of weed control, rather than relying on herbicides only.**
 - ◆ **This is important because different weed species require different kinds of weed management to be effective.**
- ◆ **Weeds also develop resistance to herbicides, which is why integrated management is needed.**

Cultural management of weeds

Cultural weed management means to use agronomic practices to reduce weeds. Examples include:



- ◆ Cleaning tractors, reapers, or combines between different fields to assure weed seeds are not transferred
- ◆ Mulching to suppress weeds

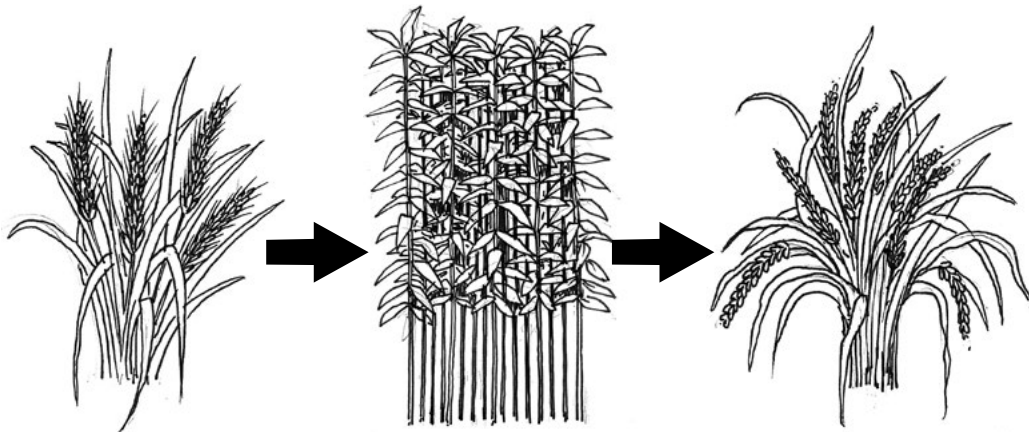

- ◆ Rotating crops (like wheat-jute-rice) breaks the cycle of weed dominance and reduces weed pressure.
- ◆ Manage fallow periods between crops: Till, mulch, or use pre-plant herbicides to prevent weeds from making seeds before you crop.

Stale seed bed

- ◆ A stale seedbed is a cultural method to control weeds.
 - ◆ About 2-3 weeks before crop seeding, prepare the seedbed by tilling and apply irrigation or wait for rain.
 - ◆ This germinates weeds so they grow.
 - ◆ 2-3 days before sowing, control weeds with shallow tillage or a non-selective herbicide.
 - ◆ Next, sow your crop and incorporate seeds (if necessary)

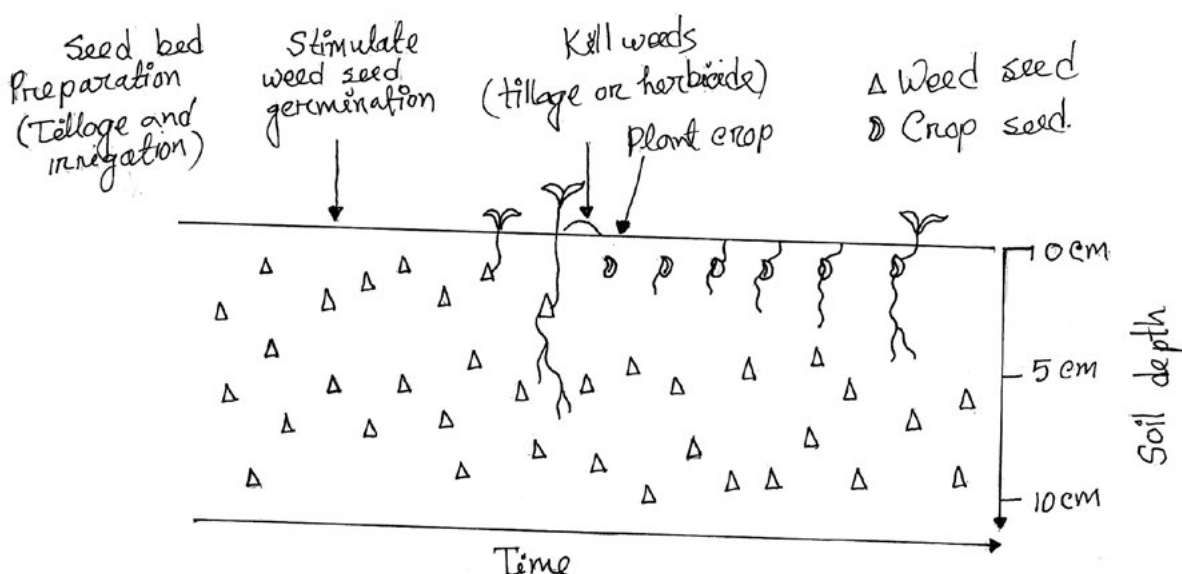

Dust mulching

Dust mulching is a cultural method to control weeds.

- 1. Dust mulching is a good cultural weed control approach for directly seeded rice.**
- 2. Apply pre-sowing irrigation to a well-prepared field.**
- 3. When the field is at best soil moisture for seeding ('Jo' or 'Vattar' condition), till again and plank.**
- 4. This will seal the soil surface with a 'soil mulch' that conserves moisture.**
- 5. The top 1-2 cm of soil will dry quickly, killing weed seeds. Lower soil layers remain moist.**
- 6. Seed immediately after field preparation in the evening to avoid moisture loss.**
- 7. Irrigate 10-20 days after seeding.**

Cultural management of weeds

Other important methods of cultural control of weeds include:

- ◆ **Use certified seeds free of weed seeds**
 - ◆ **Use competitive crop cultivars (early, vigorous seed growth with early canopy closure, long duration, high tillering, with wide and long leaves)**
- ◆ **Sow your crops in rows and lines to make manual and mechanical weeding easier.**
 - ◆ **Sow your crops on time and use the correct seed rate.**
- ◆ **Early flooding of rice at the right time helps reduce weed pressure.**

Manual and mechanical weed management

Manual and mechanical weeding can be used along with cultural and chemical control.



For perennial weeds, hand weeding can be helpful to remove their roots.



Both push and power mechanical weeders and tillers are also available for rice and maize sown in lines.

Perennial weeds may however require hand weeding to remove weeds roots that can cause regrowth.

Chemical weed control

- ◆ **Control of weeds with herbicides is often necessary in conservation agriculture or direct seeded rice.**
 - ◆ **Chemical control should always be practiced in an integrated weed management program.**
- ◆ **Herbicides are poison. Safety must be considered.**
 - ◆ **Weeds develop resistance to herbicides over time. This is why integrated weed management is needed.**

Avoid herbicide resistance

Farmers using herbicides must avoid resistance. Herbicide resistance happens when the same herbicide is applied to the same weed species season after season. Over time, the herbicide is less effective at controlling weeds.

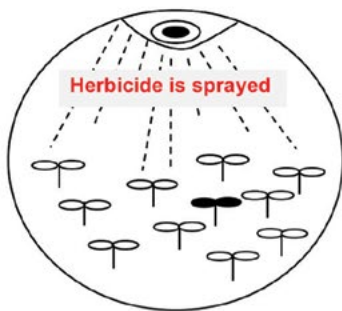

Herbicide is sprayed



One resistant weed survives



It flowers and seeds

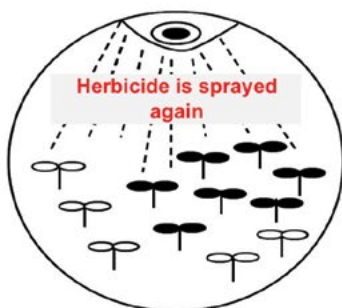

Herbicide is sprayed again...

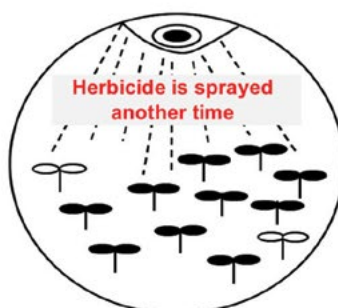

...and another time



Resistance grows over time

To avoid resistance, remove or kill weeds before they flower and set seed, and rotate herbicide types.

Types of herbicides (1)

Based on when they are applied, there are three types of herbicides, which can come in liquid or granular form.

Pre-plant (burn down) herbicides:

- ◆ Apply before sowing to kill all weed types, especially under conservation agriculture. Glyphosate is a common pre-plant herbicide, but use it with care and make sure to rotate its use with other herbicides.

Pre-emergent herbicides:

- ◆ Apply after seeding but before weeds emerge, usually 1-3 days after sowing or transplanting.



Types of herbicides (2)

Post-emergent herbicides:

- ◆ Apply after weeds are visible and have 3-4 leaves.

Review your handout on herbicide types:

- ◆ Direct seeded rice requires different herbicides than transplanted rice.
- ◆ Conservation agriculture practices often require pre-plant herbicides.

What are surfactants?

- ◆ Surfactants help pre-plant, and post-emergent herbicides to be more effective. This helps the herbicide bind to and penetrate leaves.
- ◆ Urea can be used as a surfactant. Just add it to your tank in small quantities (usually < 2 kg ha)





Review of key lessons (1)

- ◆ **Broadleaves, sedges, and grasses are the three main kinds of weeds.**
 - ◆ **Use integrated weed management to avoid herbicide resistance.**
- ◆ **Herbicides should only be used in combination with other cultural control techniques.**
 - ◆ **Herbicides should only be used after careful training.**
- ◆ **Use different herbicide products with different types of action to avoid herbicide resistance.**
 - ◆ **The three types of herbicides are preplant, pre-emergence, and postemergence.**

Review of key lessons (2)

- ◆ **Improper use of herbicides can damage your crop.**
 - ◆ **Plan carefully before you use herbicides. Mistakes cannot be corrected. Take your time and do it correctly.**
- ◆ **Monitor your fields for signs of herbicide resistance, and change products when needed.**

Session 3

Sprayers, spray technology, and sprayer maintenance

Integrated weed management
one-day training flipchart

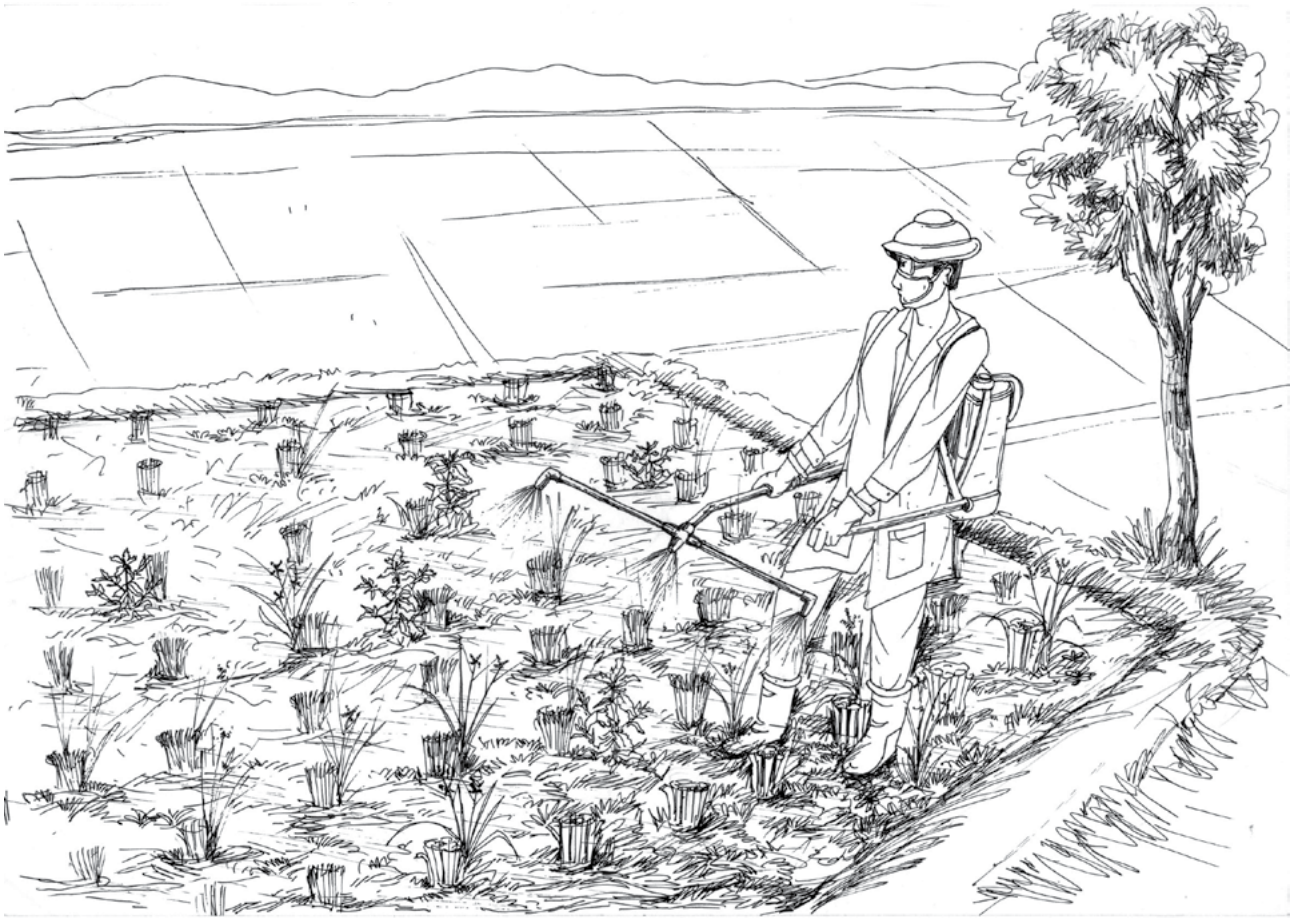

Different sprayer types

There are many kinds of sprayers available:

- ◆ Knapsack sprayers
 - ◆ Foot sprayers (pedal pump sprayers)
- ◆ Traction pneumatic sprayers
 - ◆ Tractor mounted sprayers
- ◆ Aerial sprayers

Knapsack sprayers are most commonly used for spraying herbicides. Three types of knapsack sprayers are available such as, hydraulic, manual pneumatic and battery or motorized pneumatic.

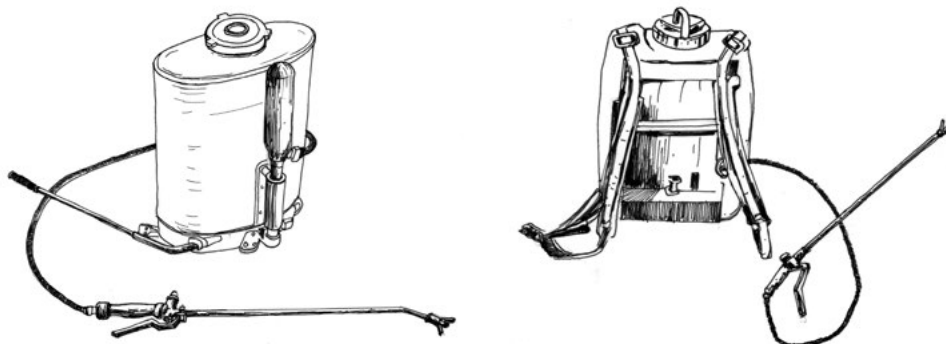

Knapsack sprayers are most common for field crops and smaller farmers.

Parts of a knapsack sprayer

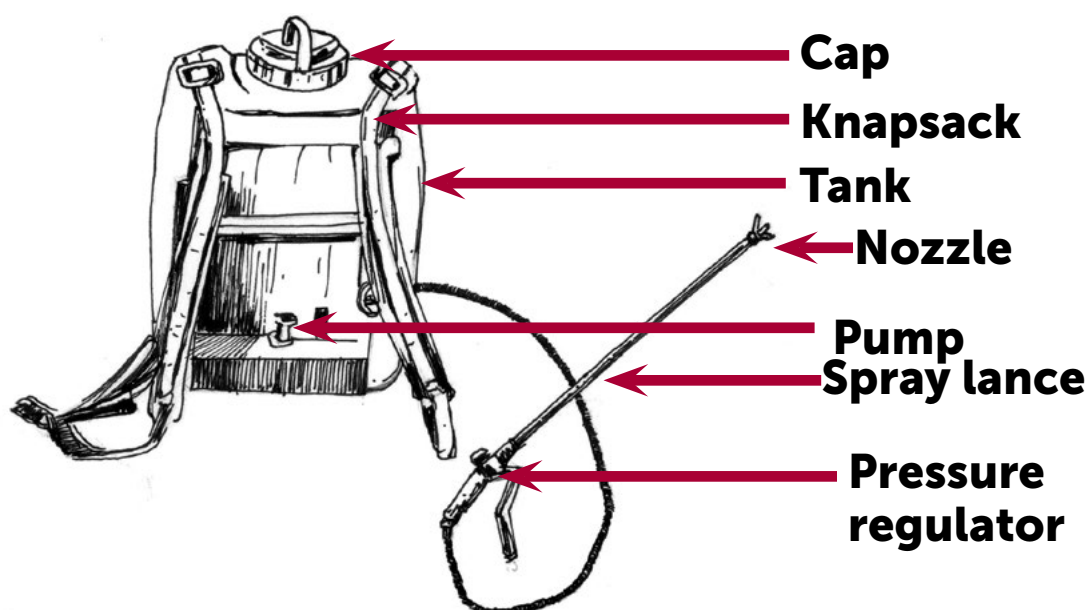

Pumps are an important part of the sprayer. They convert the water and herbicide into the spray mist.

There are two pump types:

- ◆ Pneumatic pumps force the air in an airtight sprayer to move the liquid through the spray nozzle.
- ◆ Hydraulic pumps force a definite amount of liquid through the spray nozzle under pressure.

Parts of a knapsack sprayer

Power sources include:

- ◆ Manual (right)
- ◆ Traction
- ◆ Independent motor
- ◆ Tractor engine

The spray tank contains liquid. There is an opening to put liquid in the sprayer. It has a built-in strainer and a cap.

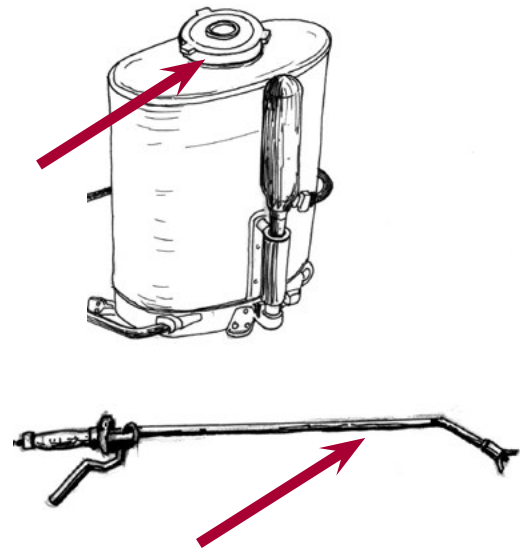
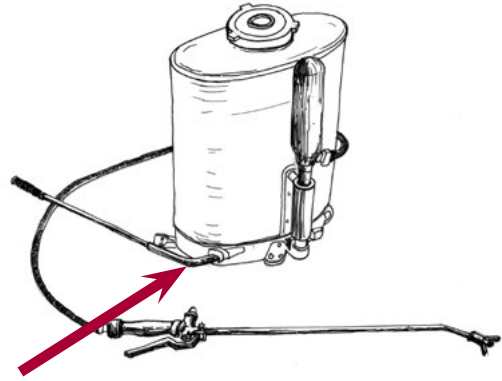

The spray lance is a brass or steel rod. It has a replaceable nozzle. Some have multiple nozzle booms.

Nozzles (1)

With pressure, the nozzle converts herbicide and water into spray. Parts include:

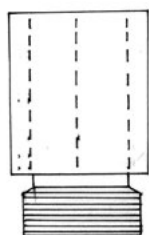

→ Nozzle body: Seats strainer and nozzle

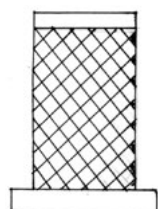

→ Strainer: Filters particles that can clog the nozzle

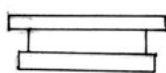

→ Spray tip: Regulates spray flow and pattern

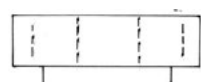

→ Nozzle cap: holds nozzle in place

Three types of nozzles are available:

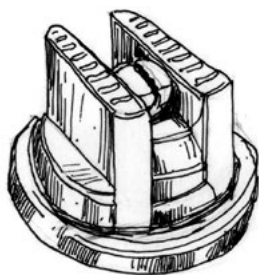

Flat fan



Flood jet

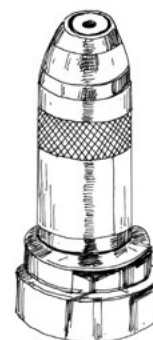

Hollow cone

Nozzles (2)

Flat fan nozzles

- ◆ Makes small droplets
- ◆ Tapered pattern from the center is for full spray
- ◆ Tapered pattern from the center is for light spray
- ◆ With multiple nozzle booms, there is 30% overlap of spray swath
- ◆ Best for multiple nozzle booms

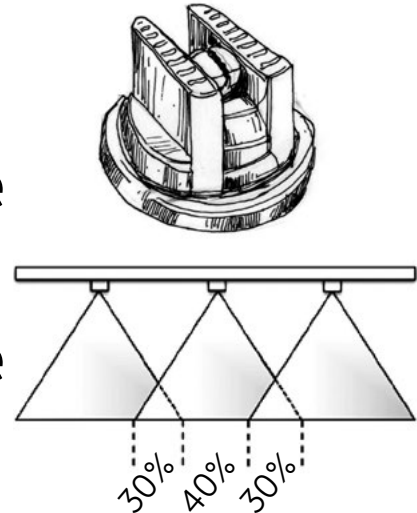

Even flat fan nozzles

- ◆ Another type of flat fan.
- ◆ The spray pattern is uniform at full flow.
- ◆ Not available for multiple spray booms
- ◆ Designed for single pass sprays over or between crop rows.

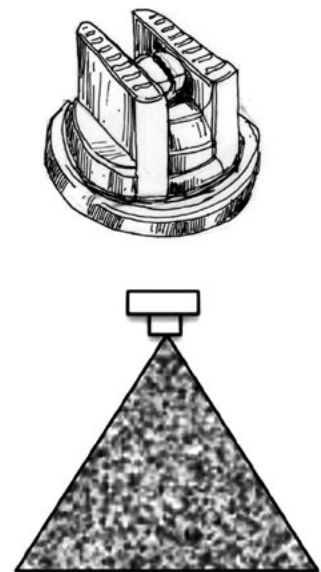

Nozzles (3)

Flood jet (cut tip) nozzles:

- ◆ Sprays heavily near the edge of the swath.
- ◆ Coarse spray with large droplets
- ◆ Wide, low-pressure spray.
- ◆ Little herbicide drift.
- ◆ If multiple booms with flat fans are not available, then flood jets are the best.

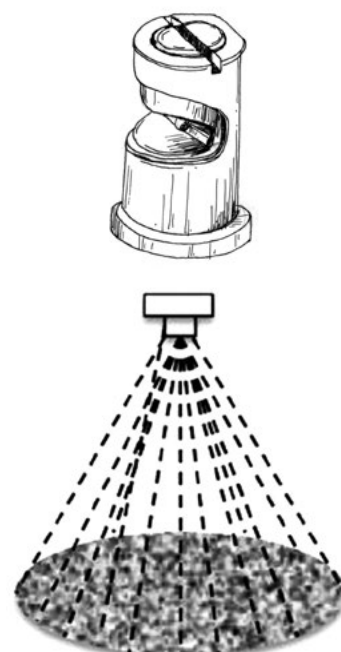

Hollow cone nozzles – Not for herbicide!

- ◆ This is **NOT** for herbicide use.
- ◆ Produces a fine spray
- ◆ Used for fungicides or insecticides

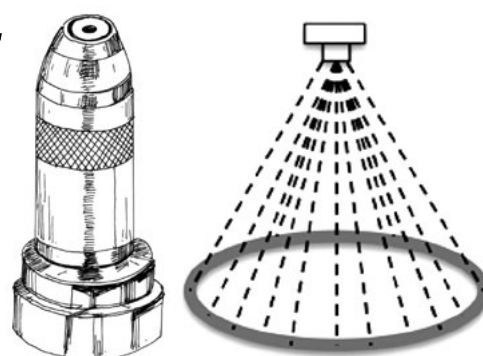

Spray bar or multiple nozzle boom

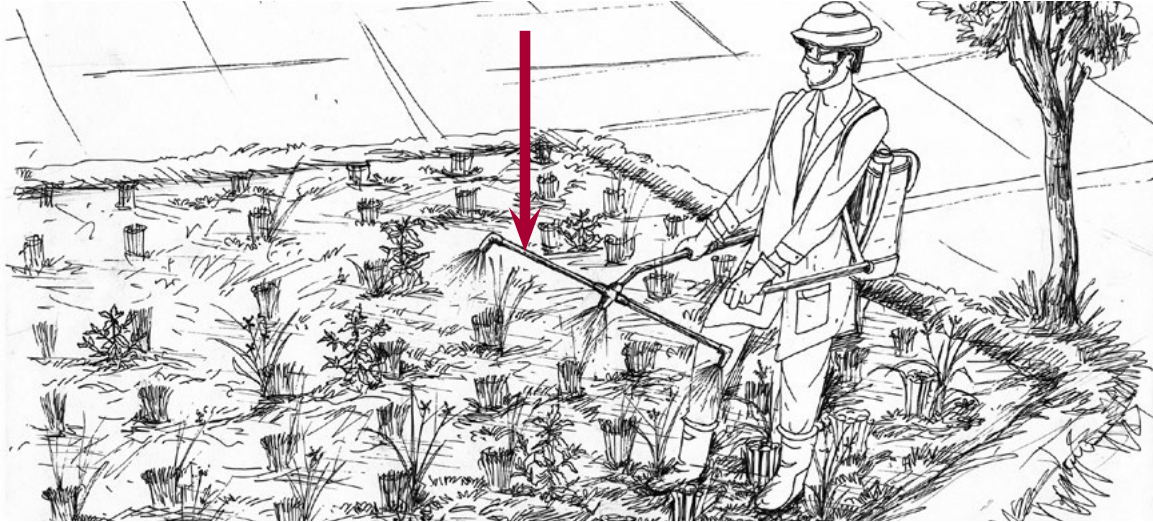

- ◆ This is the 'arm' of the sprayer.
- ◆ Nozzles are usually 50 cm apart.
- ◆ Manual sprayers have short booms.

Pressure regulator

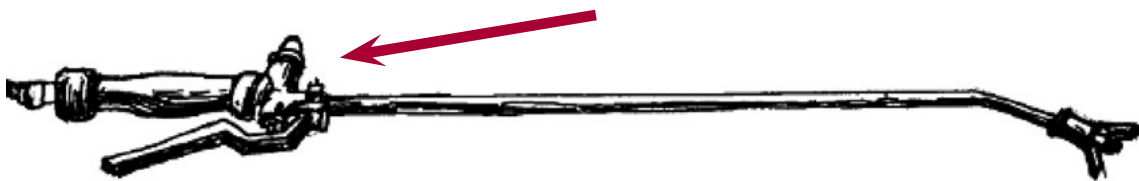

- ◆ This boom has one nozzle.
- ◆ The regulator maintains constant pressure for consistent spray.
- ◆ Some regulators have gauges to maintain pressure.



How do you determine spray swath with a multiple nozzle boom?

- ◆ First measure the spacing between nozzles
- ◆ If spacing is 50 cm for a 2 nozzle boom, then swath is $(2 \times 50) - 15 = 85$ cm (subtract 15 cm due to spray overlap)
- ◆ For a three nozzle boom, it is $(3 \times 50) - 30 = 120$ cm (subtract 30 cm due to spray overlap)

How high should you hold the spray nozzle?

- ◆ Nozzle height is important.
- ◆ With multiple nozzle booms, height is very important.
- ◆ Adjust height so that 30% of the spray from each nozzle overlaps.

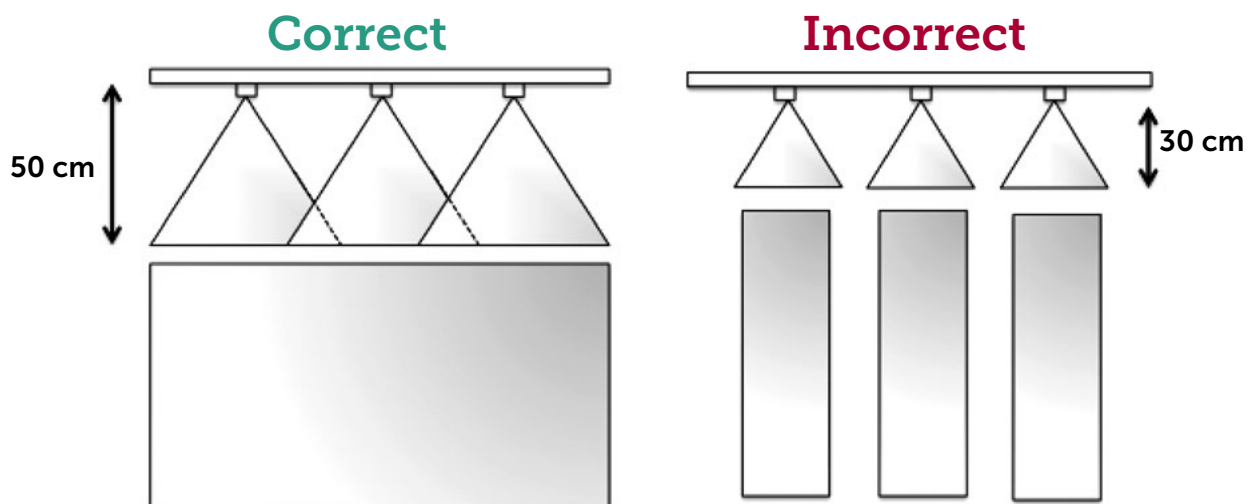

- ◆ Knee height (50 cm) from the soil is best height for pre-emergent herbicide.
- ◆ For post-emergent or pre-plant herbicides, 50 cm from the top of weed leaves is best.

How do you regulate pressure?

- ◆ Correct spraying depends on tank pressure.
- ◆ If pressure changes when spraying, herbicides are less effective and you lose money.

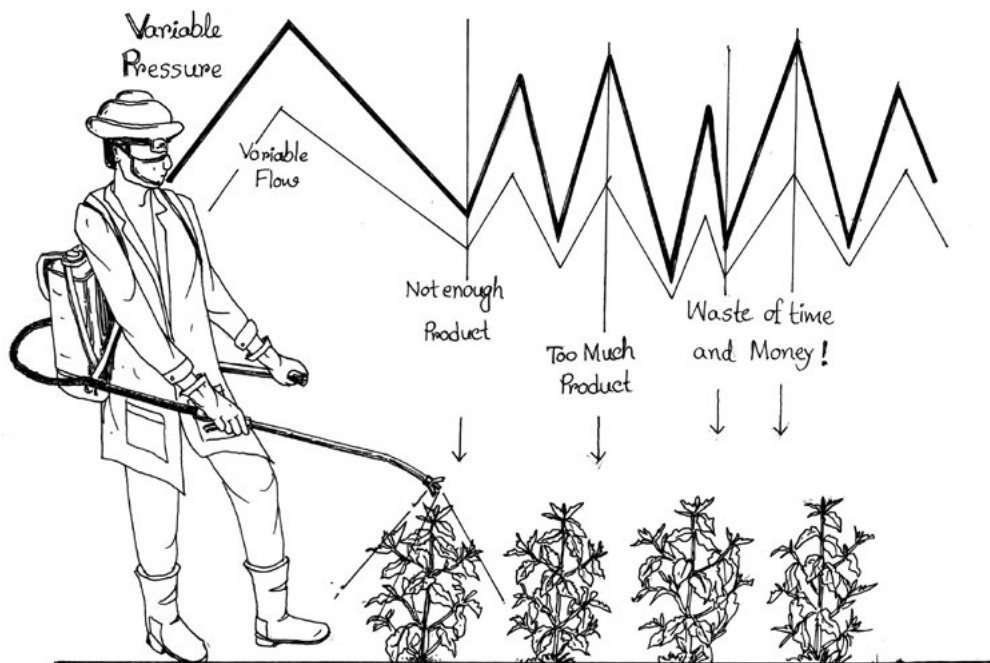

- Constant flow valves that operate at 1, 1.5, 2 and 3-bar pressure (1 bar = 14.5 psi) stabilize pressure.
- They reduce spraying effort and improve application.

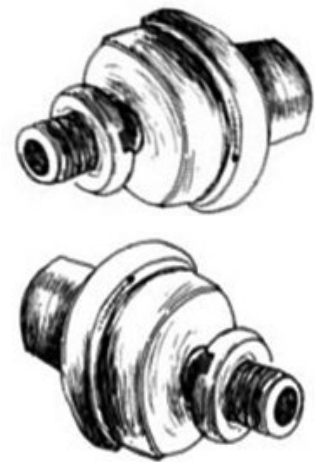

Constant flow valve

Spray shields and hoods

- ◆ Used to spray between rows of crops.
- ◆ Some herbicides can damage crops so hoods are needed for post-sowing sprays.
- ◆ Shields are metal or plastic.
- ◆ They are placed over nozzles.
- ◆ The bottom of the shield or hood is open.
- ◆ Hoods work best for maize or widely spaced crops.

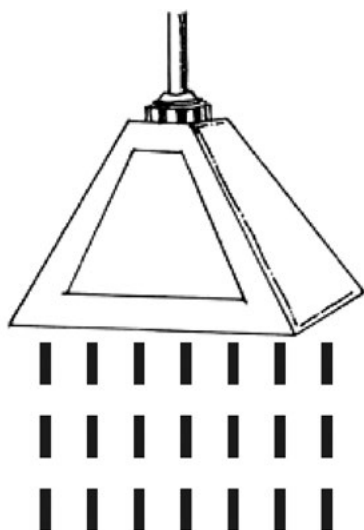

A hood for an even flat fan nozzle showing spray direction

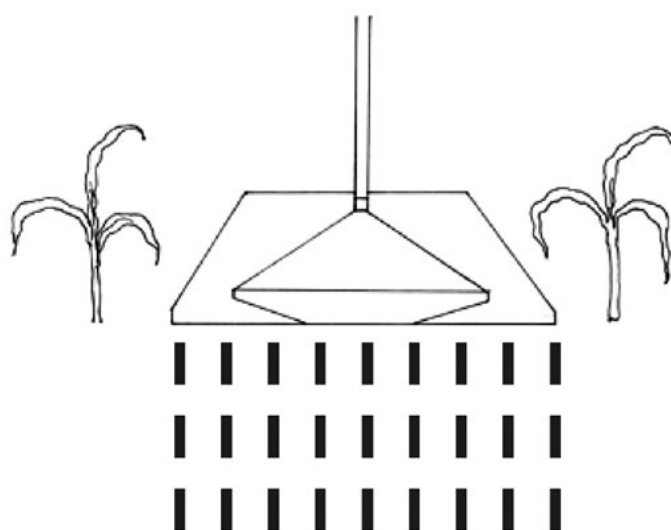

A spray shield showing spray direction for widely spaced row crops like maize

Avoid spray drift!

- ◆ Drift is when the spray does not fall on the crop or when spray drifts to neighboring fields.
- ◆ Drift can injure or kill neighboring crops.
- ◆ This wastes farmers' time and money.
- ◆ Drift is also bad for the environment, and can hurt people and animals.

How can drift be minimized?

- ◆ Follow herbicide container guidelines.
- ◆ Use shields or hoods.
- ◆ Only spray when there is little wind (evening or early morning).
- ◆ Use nozzles like flood jets that make large drops of spray.
- ◆ Reduce nozzle height if it is windy.



Maintaining sprayers (1)

Only use clean water. Do not use canal or pond water. When spraying and cleaning.



◆ Use the inlet screen when adding herbicide and water to the tank.

◆ After use, remove debris.

◆ Wear protective clothing and gloves when cleaning sprayers.

◆ Remove clogged nozzles, rinse with water, and clean with a toothbrush. Throw away the toothbrush.



Maintaining sprayers (2)

- ◆ Never clean nozzles with wire or metal.
- ◆ Clean sprayers after each use.
- ◆ Scrub the tank with detergent.
- ◆ Clean screens with kerosene and a brush.
- ◆ Flush the sprayer and boom with clean water.
- ◆ Never dump herbicide residues into a canal, river, or pond.

Store sprayers out of children's reach

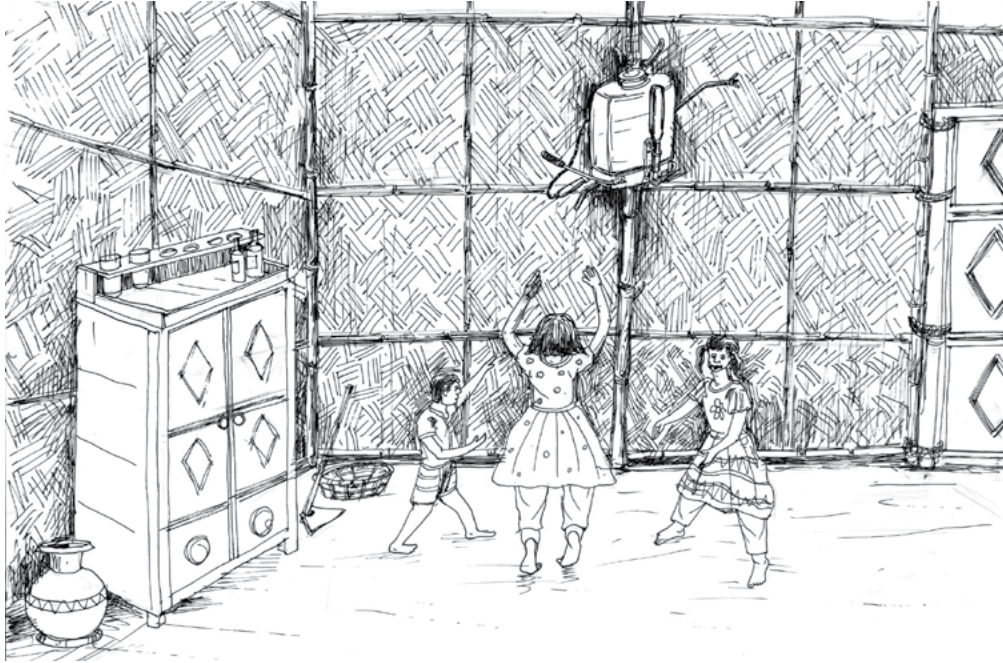

Store herbicides in a locked box and out of children's reach

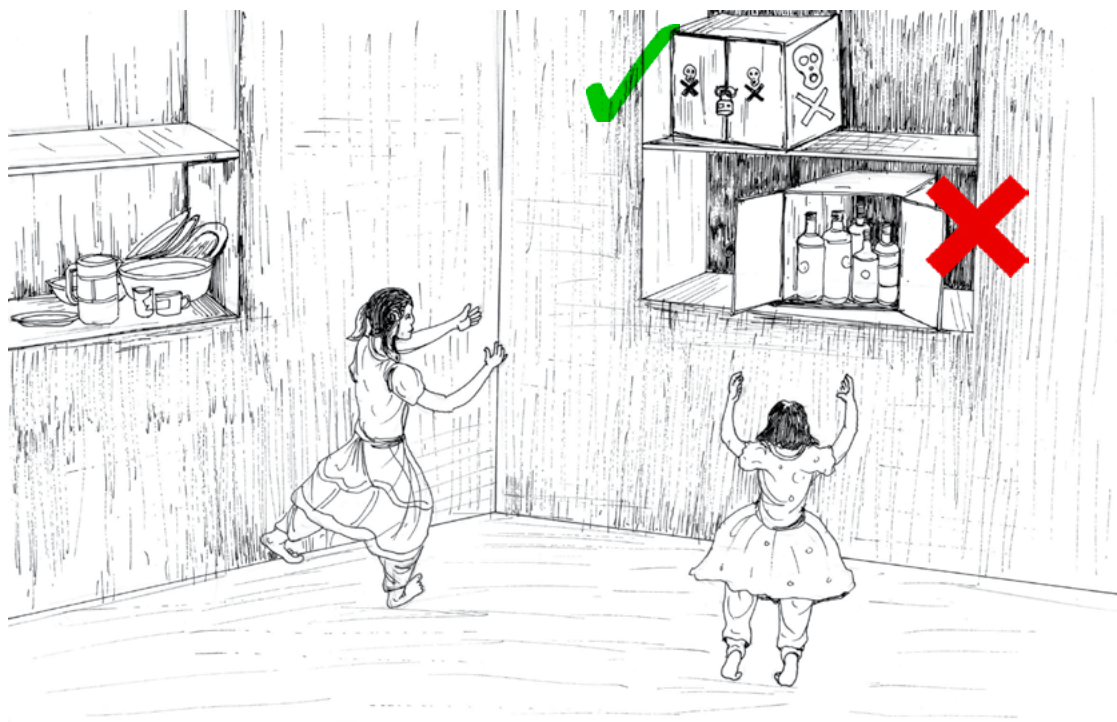



Review of key lessons

- ◆ Knapsack sprayers are common for small farmers.
- ◆ The pump, tank, lance, nozzles, boom, and regulator are important sprayer parts.
- ◆ Flat fan and flood jet nozzles are best for herbicides.
- ◆ Hold nozzles about 50 cm above the soil or weeds.
- ◆ Regulate even pressure to improve spray effectiveness.
- ◆ Use spray shields or hoods if spraying within a row crop.
- ◆ Do not spray when it is windy.
- ◆ Always thoroughly clean your sprayer after use.

Session 4

Practical calibration

Integrated weed management
one-day training flipchart

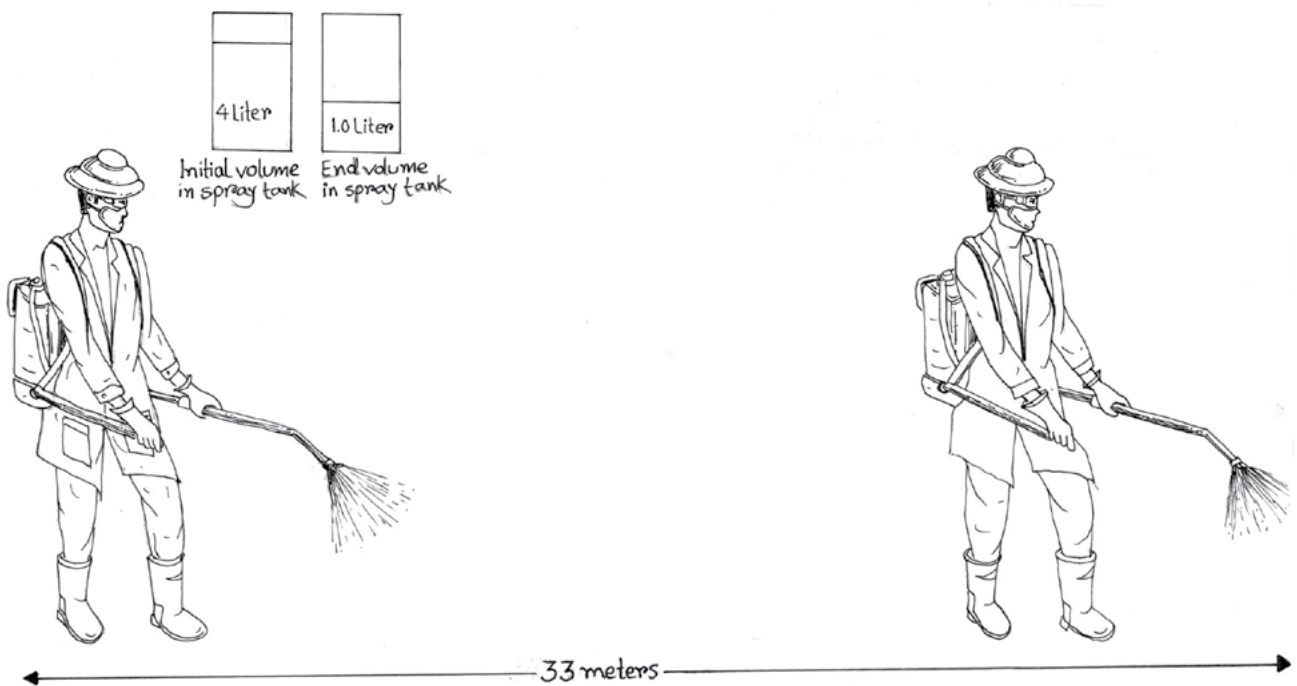

What does calibration mean?

- ◆ Calibration is determining the sprayer or herbicide output for a known area.
- ◆ Calibration gives the desired spray pattern and coverage of the field.
- ◆ Calibration should be done each time you use different herbicides, or after you cleaned the sprayer.
- ◆ Before calibrating, know the size of the area you will spray.
- ◆ Calibrating a sprayer requires a test area. We usually use an area of 33 m × 3 m (i.e. approximately 100 m²) as shown below.



But what about granular herbicides?

- ◆ Granular herbicides come in small, solid balls like fertilizers.
- ◆ They cannot be sprayed.
- ◆ Granular herbicides are broadcasted like fertilizer.
- ◆ Read the herbicide bottle to determine the weight of herbicide required per unit of land area.
- ◆ For transplanted rice, granular herbicides are applied to the floodwater 2-3 days after transplanting.
- ◆ Granular herbicides can be broadcast without mixing, though for transplanted rice they can be mixed with sand and broadcasted.
- ◆ This helps to improve how they are spread over the field.

Now back to calibrating your sprayer

**Select a test
plot and
mark it**

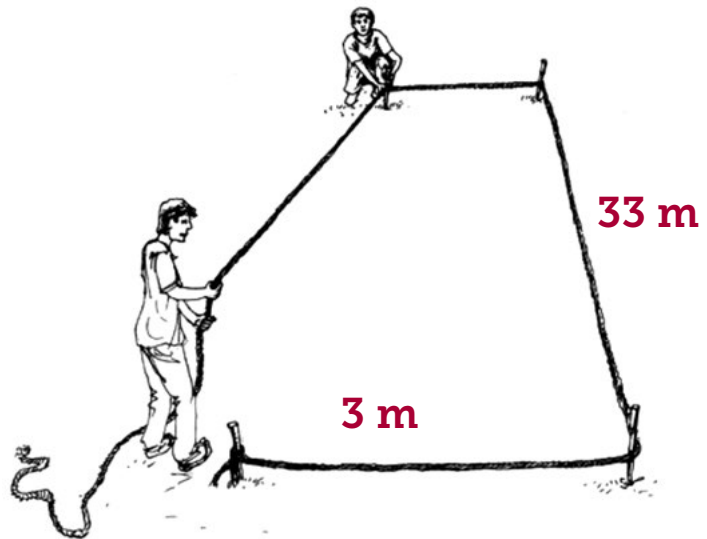

Select a sprayer and nozzle

- ◆ Flood jet nozzles are preferred
- ◆ If using a multiple nozzle boom, make sure it is straight and there is 50 cm between the nozzles.

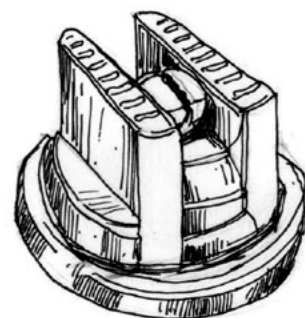
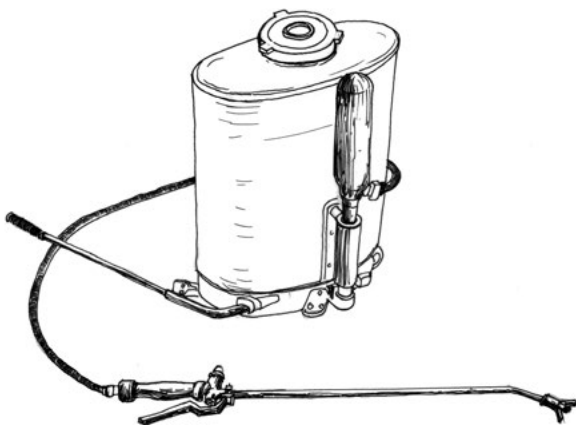

Before calibrating your sprayer, protect yourself!

- ◆ Herbicides are poison.
- ◆ Even when calibrating and mixing sprayers, wear the right protective clothing.
- ◆ Jacket arms should cover gloves boots to keep out herbicides.
- ◆ Trousers should cover boots to keep out herbicides.

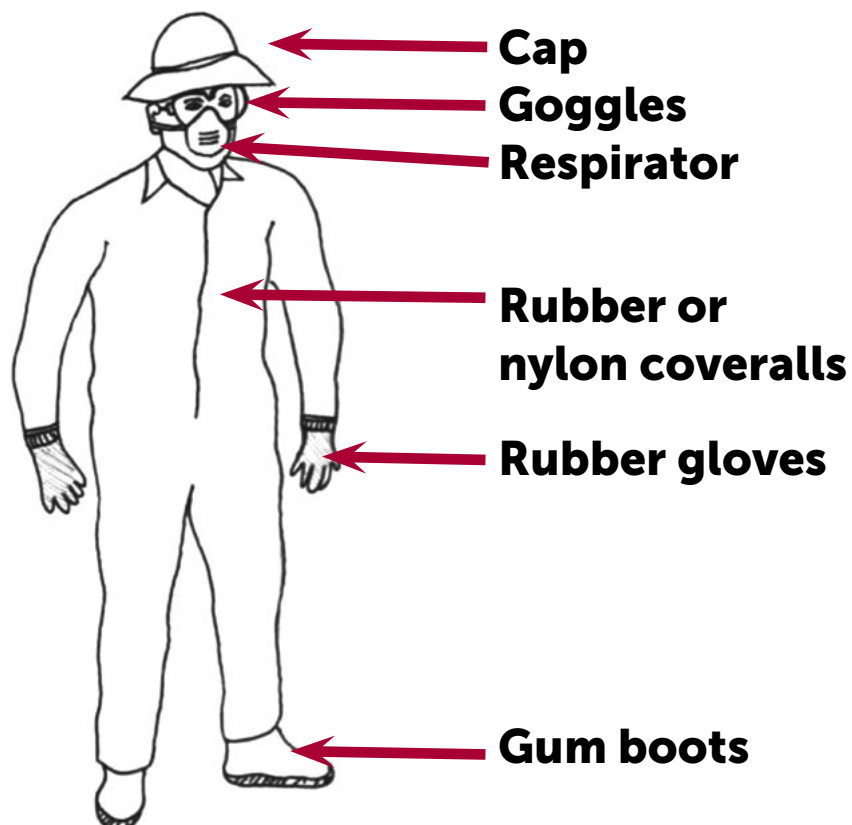

Calculate the water and spray volume

- ◆ Add 4 liters of water to the sprayer and close it.
- ◆ Measure how much water is sprayed per in the selected area that you are using for calibration.
- ◆ Do this by attaching empty plastic bottles to the nozzle with tape and spraying.
- ◆ For multiple nozzle booms, check that the same amount sprayed is per nozzle.

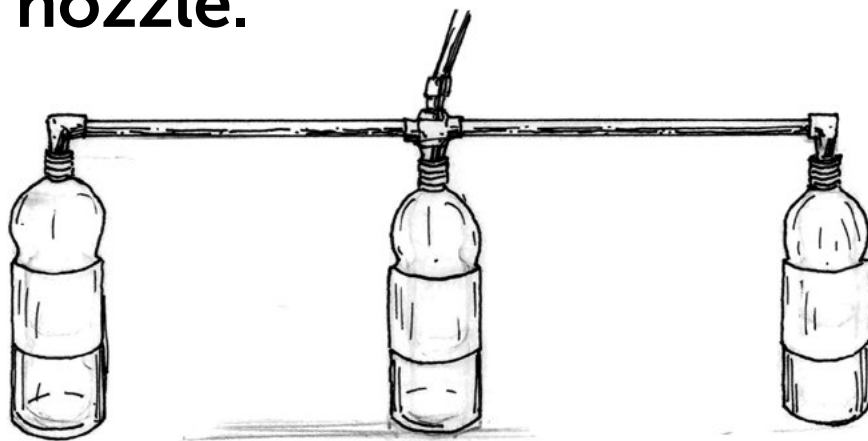

Calculate the water and spray volume

◆ Refill the tank to 4 liters. Walk in a straight line across the test plot while evenly pumping the sprayer. Record the time of each pass.

◆ For a multiple three nozzle boom with flat fans (1.3 m spray swath) turn around at the end and make a second pass and stop.

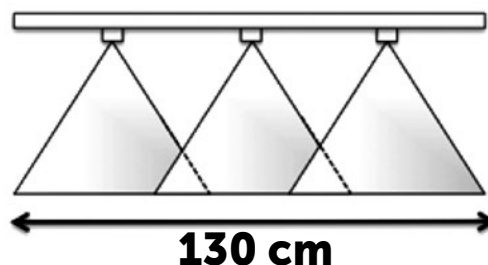

◆ For a single flood jet nozzle (1.5 m spray swath) turn around at the end and make a second pass and stop.

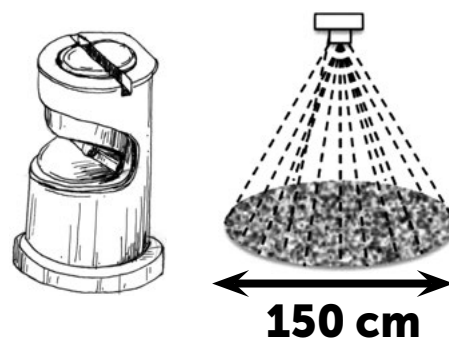

◆ For a single flat fan nozzle (0.5 m spray swath) turn around at the end and make two more passes.

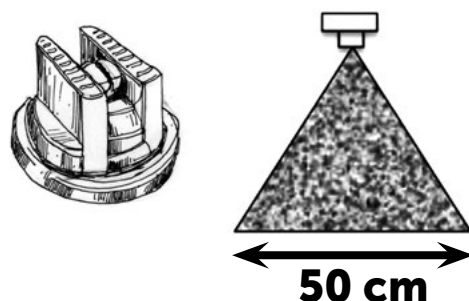



Calculate water requirements

Next calculate water requirements for one hectare:

- ◆ Initial water volume in the tank = 4 L
- ◆ End volume in the tank after spraying about 100 m² = 3 L
- ◆ Volume consumed for spray = 3 L
- ◆ 3 L water required to cover about 100 m² or 1/100th of 1 hectare
- ◆ So, $3 \times 100 = 300$ L is required to spray 1 hectare.

Now calculate the number of tanks per hectare:

- ◆ 300 L is required for 1 hectare
- ◆ Capacity of a tank = 15 L
- ◆ $300 \text{ L} / 15 \text{ L} = 20$ tanks for 1 hectare

How to adjust calibration

Change speed:

- ◆ Increased speed reduces spray volume per hectare
- ◆ Decreased speed increases spray volume per hectare

Change nozzle tip:

- ◆ Larger tips increase spray per hectare

Change pressure:

- ◆ Use this as a last choice.
- ◆ Increased pressure increases output per hectare

Note that if speed, nozzle tip, or pressure are changed, you need to calibrate the sprayer again.

Add herbicide to the tank

- ◆ Wear all protective clothing when working with herbicides.



- ◆ Check what the recommended rate of the herbicide is per hectare. Convert this to local land units if necessary.

An example:

- ◆ For a rate of 100 grams of herbicide per hectare
- ◆ Prepare a stock solution by mixing herbicides. For example, if 20 tanks needed for 1 ha, then mix 100 grams of herbicide in 20 liters of water. Mix well before use.
- ◆ Pour 1 L of herbicide stock solution into a sprayer tank.
- ◆ Fill the tank with clean water and mix again before spraying.

Add surfactants

- ◆ Surfactants help pre-plant, and postemergent herbicides to be more effective.
- ◆ Urea is often used as a surfactant at a rate of 1.5–2.0 kg urea ha⁻¹ added to the tank
- ◆ Most non-ionic surfactants are applied at 2% of the water and herbicide in the tank.



Review of key messages (1)

- ◆ Calibration is the process of determining the sprayer output for a known area.
- ◆ Calibration, field size, droplet size, nozzle size and spacing, nozzle capacity, speed and pressure all influence herbicide effectiveness.
- ◆ Wear mask, gloves, coveralls, hat, goggles, gumboots, etc. as a safety measure before mixing and preparing, and applying herbicides.
- ◆ Select the appropriate sprayer and nozzles.

Review of key messages (2)

- ◆ **Make sure the sprayer is at the correct pressure, and that you hold the spray nozzles (called a boom) at the right height.**
- ◆ **Calibrate the sprayer using a field for testing**
- ◆ **Calculate water volume per field area.**
- ◆ **Calculate tank number.**
- ◆ **Calculate herbicide rate per tank and add.**
- ◆ **Re-calibrate if pressure, nozzles, or speed is changed.**

Session 5

Practical herbicide spraying exercise

Integrated weed management
one-day training flipchart



Review how to wear the correct protective clothing

- ◆ Herbicides are poison. They can cause harm to your and other people's health.
- ◆ Wear the right protective clothing.

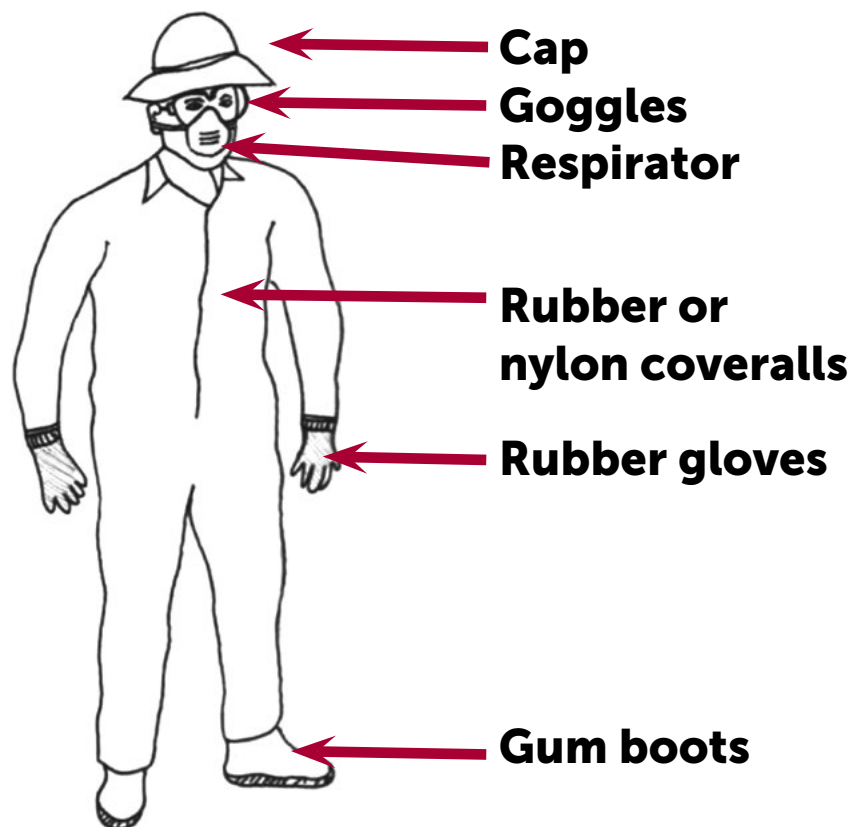

How to apply herbicides

Select the right nozzle tips for herbicides

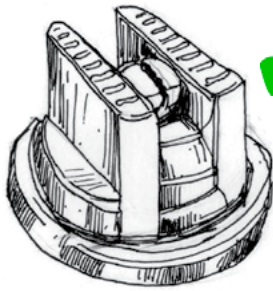

Flat

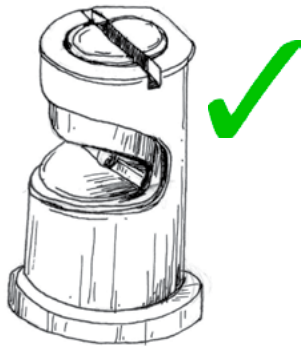

Flood

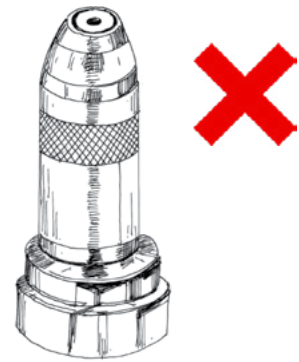

Hollow

Use the correct spray height and direction



Correct



Incorrect

How to apply herbicides

Cross the field in the right direction

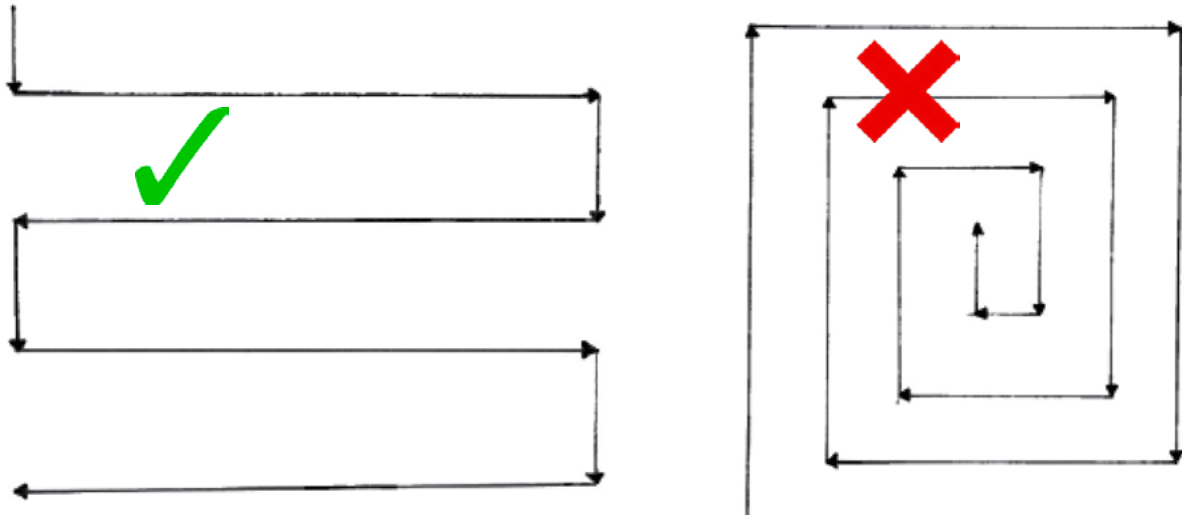

Do not swing the spray boom



Avoid contaminating the environment



Beside: a field and surrounding environment

What is the environment?

- ◆ Person(s) spraying and people near spraying
- ◆ Plants in and around the field
- ◆ Animals in and around the field
- ◆ Soil and water in and outside the crop field
- ◆ Water in nearby areas like canals and rivers

Minimize environmental contamination

- ◆ Select herbicides with low environmental impact.
- ◆ Read the herbicide label and follow instructions.
- ◆ Do not spray when people or animals are near.
- ◆ Do not spray when windy.
- ◆ Use herbicide efficiently and avoid over-application.
- ◆ Do not use herbicide bottles for any other purpose than holding herbicides.
- ◆ After use, crush and bury herbicide bottles away from rivers or canals. Bury at least 50 cm deep. Do not burn them or throw them away.
- ◆ Store herbicides in locked containers.

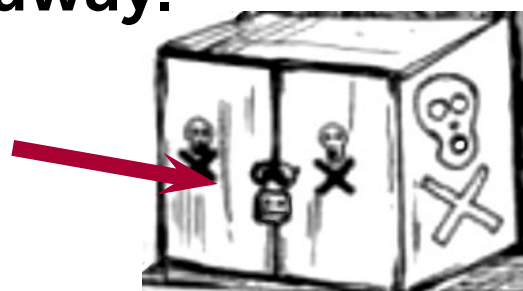



Review of key messages

- ◆ Wear protective clothing when mixing, spraying, and disposing of herbicides.
- ◆ Select nozzle tips for herbicides.
- ◆ Multiple nozzle booms have better accuracy and efficiency.
- ◆ Use the right spray height and direction.
- ◆ Walk the right path when spraying in the field.
- ◆ Do not swing the spray boom.
- ◆ Do not spray herbicides when it is windy, or when people or animals are nearby.
- ◆ Properly dispose of herbicide bottles.
- ◆ Always store herbicides in locked boxes away from children.

Session 6

Review, post-test and closing

**Integrated weed management
one-day training flipchart**



Review, post-test and closing

- ◆ What are major types of weeds?
- ◆ What is integrated weed management?
- ◆ What are the major parts of a sprayer?
- ◆ How many types of nozzles are available? Which one is suitable for spraying herbicide?
- ◆ What factors are to be considered during calibration of a sprayer?
- ◆ How can a spray operator maintain personal and environmental safety?
- ◆ What are the different types of herbicides and how would you select them?
- ◆ What is herbicide resistance and how can it be avoided?
- ◆ What is a surfactant?

Annexes

Annex 1

Pre-evaluation form

Farmer and service Providers' training pre-evaluation form: Integrated weed management

Venue:
(to be completed by the facilitator)

Batch:

Date:

Name of trainee: _____

Please put tick (✓) mark on the correct answers

Total time: 10 minutes

Question	Answer		
1. What do weeds compete with crops for?	Space on field bunds	Water, oxygen, light,	Water, nutrients, and light
2. Which is NOT a principle of integrated weed management?	Cultural control	Use herbicides each time you plant	Mechanical control
3. When should weeds be controlled?	After they seed	When they flower	Before they compete, and before flowering
4. Which is not a class of weeds?	Broadleaves	Woody	Sedges
5. Which is not an appropriate nozzle for herbicides?	Flat fan	Flood jet	Hollow cones
6. When should you apply a preemergent herbicide?	After weeds are in the field	Before you irrigate	About 0-3 days after the crop is sown
7. How much overlap in spray swath should there be with a multiple spray boom?	30%	100%	50%
8. What is a 'stale seedbed'?	A rice seedbed with too few seeds	Irrigating, germinating, and then tilling in weeds	A field with crops that do not germinate
9. How does herbicide resistance grow?	The same herbicide is applied too frequently	Farmers spray too many different kinds of herbicides	Farmers use herbicides and mechanical control
10. How can calibration be adjusted if spray volume is not right?	Change herbicides	Slow down or speed up walking	Change pressure

Post-evaluation form

Farmer and service Providers' training pre-evaluation form: Integrated weed management

Venue:

Batch:

Date:

Name of trainee: _____

Please put tick (✓) mark on the correct answers

Total time: 10 minutes

Question	Answer		
1. What do weeds compete with crops for?	Space on field bunds	Water, oxygen, light,	Water, nutrients, and light
2. Which is NOT a principle of integrated weed management?	Cultural control	Use herbicides each time you plant	Mechanical control
3. When should weeds be controlled?	After they seed	When they flower	Before they compete with the crop, and before flowering
4. Which is not a class of weeds?	Broadleaves	Woody	Sedges
5. Which is not an appropriate nozzle for herbicides?	Flat fan	Flood jet	Hollow cones
6. When should you apply a preemergent herbicide?	After weeds are in the field	Before you irrigate	About 0-3 days after the crop is sown
7. How much overlap in spray swath should there be with a multiple spray boom?	30%	100%	50%
8. What is a 'stale seedbed'?	A rice seedbed with too few seeds	Irrigating, germinating and then tilling in weeds before sowing	A field with crops that do not germinate
9. How does herbicide resistance grow?	The same herbicide is applied too frequently	Farmers spray too many different kinds of herbicides	Farmers use herbicides and mechanical control
10. How can calibration be adjusted if spray volume is not right?	Change herbicides	Slow down or speed up walking	Change pressure

Answers to pre- and post-test questions

- 1. Water, nutrients, and light**
- 2. Use herbicides each time you plant**
- 3. Before they compete with the crop, and before flowering**
- 4. Woody**
- 5. Hollow cone**
- 6. About 0-3 days before the crop is sown**
- 7. 30%**
- 8. Irrigating, germinating, and then tilling in weeds before sowing**
- 9. The same herbicide is applied too frequently**
- 10. Slow down or speed up walking AND change pressure (both answers should be noted to be correct)**

Annex 2

Common herbicides

Herbicide recommendations for transplanted rice							
Si. No.	Herbicide common name	Common product name	Risk to environment and human health	Dose (g active ingredient/ha)	Product dose (ml or gm/ha)	Weed control	Time and method of application
PRE-EMERGENCE							
1	Butachlor 50 EC	Machete	High – not permitted for use by USAID	1250 to 1500	2500 to 3000	Grasses, broadleaf and annual sedges	Mix in 150 kg sand and broadcast uniformly in standing water (4-5 cm depth) 2-3 days after transplanting or spray at 375 lt/ha water
2	Pretilachlor 50 EC	Rifit, Erazé	High toxicity to fish – not approved by USAID.	750	1500	Grasses, broadleaf and annual sedges	
3	Pendimethalin 30 EC	Stomp	Low to humans. Moderate toxicity to fish	1000	3333	Grasses and broadleaved and some sedges	
4	Mefecanet + Bensulfuron methyl		Medium. Use Bensulfuron methyl with care as a surfactant			Mefecanet controls annual grasses especially <i>Echinochloa</i> and bensulfuron broadleaf and annual sedges	
POST-EMERGENCE							
2	Bispyribac-sodium 10 SP	Nominee Gold, Adora	Low (limited scientific information)	20-25	200-250	Grasses, broadleaf and sedges. Effective on <i>Echinochloa</i> spp. Weak on <i>Leptochloa chinensis</i> and <i>Dactyloctenium aegyptium</i> . Effective on annual sedges but suppresses perennial sedge (<i>Cyperus nutsedge</i>)	Spray 15-25 days after transplanting using 300 liter water/ha when weeds are 2-4 leaf stage.
2	Bispyribac 10 SP + pyrazosulfuron 10 WP	Nominee Gold/Adora + Sathi	Low, but not permitted for use by USAID (Not EPA registered)	20+ 20	200+200	Grasses, broadleaf and sedge. Use this mixture if weed flora is complex and dominated by <i>Cyperus rotundus</i> .	
3	2,4-D ester 38 EC		Medium, but approved for use in USAID projects only by trained applicators	500	1315 (if 2,4-D ester 38 EC) or 625 ml (if 2,4-D sodium salt 80%)	Broadleaf and suppresses sedges	
4	Fenoxaprop + ethoxysulfuron	Whip super or Rice star + sunrice	High – toxic effects to non-target species	60 + 18	645 + 120	Grasses, broadleaved and sedges	
6	Metsulfuron + chlorimuron 20 WP	Almix	Medium-high	4 (2+2)	20	Broadleaved and sedges	

Herbicide recommendations for direct seeded rice (DSR)

Sr. No.	Herbicide common name	Product name	Risk to environment and human health	Dose (active ingredient/ha) ml	Product dose (ml/ha)	Weed control	Time and method of application
PRE-EMERGENCE							
1	Pendimethalin 30 EC	Stomp	Low to humans. Moderate toxicity to fish	1000	3333	Grasses, broadleaf and sedges	Apply within 0-3 days after seeding using 375-500 lt/ha water volume. Good soil moisture is important for its efficacy.
2	Pretilachlor with safner 30.7EC	SOFIT	Low, but moderately toxic to fish	500	1629	Grasses, broadleaf and sedges	
POST-EMERGENCE							
1	Bispyribac-sodium 10 SP	Nominee Gold, Adora	Surfactants can be more toxic to people and animals than the active ingredients. Slightly, moderately or highly toxic to fish.	25	250	Control grasses, broadleaf and sedges. Very effective on <i>Echinochloa</i> species and <i>Ischaemum rugosum</i> but poor on <i>Leptochloa chinensis</i> , <i>Dactyloctenium aegyptium</i> .	Spray 15-25 days after transplanting using 300 liter water/ha when weeds are 2-4 leaf stage.
2	Bispyribac-sodium + pyrazosulfuron	Nominee Gold + Sathi	See above comment	25 + 20	250 + 200	For complex weeds flora and control of grasses, broadleaf and sedges. Use if weeds are dominated by <i>Cyperus rotundus</i>	
3	Fenoxaprop - ethyl with safner + ethoxysulfuron	Ricestar + sunrice	See above comment	90 + 18	1300 + 120	For complex weed flora and control grasses, broadleaves and sedges. This is effective on emerging DSR weeds like <i>Leptochloa</i> and <i>Dactyloctenium</i>	
4	Penoxsulam	Granite	See above comment	22.5		Grasses, broadleaved and sedge	

Herbicides for wheat

Sr. No.	Herbicide common name	Product name	Risk to environment and human health	Dose (active ingredient/ha) ml	Product dose (ml/ha)	Weed control	Time and method of application
PRE-PLANT							
1	Glyphosate	Roundup	Medium, approved for use in USAID projects only by an experienced and trained applicator	1000	1000	Non-selective burn down herbicide	At least 5 days before sowing, apply to leaves of existing weeds with 350-400 L water per hectare. 1.5-2.0 kg urea ha ⁻¹ should be placed in the sprayer tank with water and glyphosate.
PRE-EMERGENCE							
1	Pendimethalin 30 EC	Stomp	Low to humans. Moderate toxicity to fish	1000	3333	Grasses and broadleaved	Apply immediately after sowing using 375-500 lt/ha water volume

Herbicides for wheat (continued)

Sr. No.	Herbicide common name	Product name	Risk to environment and human health	Dose (active ingredient/ha) ml	Product dose (ml/ha)	Weed control	Time and method of application
POST-EMERGENT HERBICIDE							
1	Fenoxaprop-p-ethyl 10 EC	Whip Super	Surfactants can be more toxic to people and animals than the active ingredients. Slightly, moderately or highly toxic to fish.	100-120	1000-1200	Grasses, broadleaved and some sedges	Spray 30-35 days after sowing using 300 liter water/ha
2	Carfentrazone 40 WF	AIM	See above	20	50	Broadleaf weeds. Also effective on <i>Solanum</i> spp and <i>Malva parviflora</i> which are not controlled by 2,4-D and metsulfuron	Spray 30-35 days after sowing using 300 liter water/ha
3	2,4-D sodium salt 80% or easter salt		Medium, but approved for use in USAID projects only by trained applicators	500	62.5 (2,4-D sodium 80%); 1300 (2,4-D ester 38%)	Broadleaf weeds	Spray 30-35 days after sowing using 300 liter water/ha

Herbicides for maize

Sr. No.	Herbicide common name	Product name	Risk to environment and human health	Dose (active ingredient/ha) ml	Product dose (ml/ha)	Weed control	Time and method of application
PRE-PLANT							
1	Glyphosate	Roundup	Medium, approved for use in USAID projects only by an experienced and trained applicator	1000	1000	Non-selective burn down herbicide	At least 5 days before sowing, apply to leaves of existing weeds with 350-400 L water per hectare. 1.5-2.0 kg urea ha ⁻¹ should be placed in the sprayer tank with water and glyphosate.
PRE-EMERGENCE							
1	Pendimethalin 30 EC	Stomp	Low to humans. Moderate toxicity to fish	1000	3333	Grasses and broadleaved	Apply immediately after sowing using 375-500 lt/ha water volume

Note - There are few herbicides suitable for maize that are approved for use by USAID. This necessitates the use of integrated weed management methods to avoid the development of herbicide resistance by use of products in this table.

Annex 3

Targeting pre-plant, pre-emergent and post-emergent herbicides to specific weed classes and species (select herbicides in this module)

(+ = controlled, - = not controlled, ± = suppressed, na = not applicable)

	Weed species	Pre-Plant	Pre-emergence	Post-emergence					
		Glyphosate	Pendimethalin	Bispyribac	Penoxsulam	Fenoxaprop	Ethoxysulfuron	2,4-D	Chlorimuron + metsulfuron
A. Grasses									
1	<i>Echinochloa crus-galli</i>	+	+	+	+	+	-	-	-
2	<i>E. colona</i>	+	+	+	+	+	-	-	-
3	<i>Leptochloa chinensis</i>	+	+	-	-	+	-	-	-
4	<i>Ergrostis japonica</i>	+	+	-	-	+	-	-	-
5	<i>Dactyloctenium aegyptium</i>	+	+	-	-	+	-	-	-
6	<i>Eleusine indica</i>	+	+	-	±	+	-	-	-
7	<i>Bracharia reptans</i>	+	+	-	-	+	-	-	-
B. Broadleaves									
8	<i>Eclipta alba</i>	+	+	+	+	-	+	+	+
9	<i>Caesulia axillaris</i>	+	na	na	+	-	na	+	na
10	<i>Sphenochloa zeylenica</i>	+	+	+	+	-	na	+	na
11	<i>Alternanthera sessile</i>	+	+	na	±	-	na	+	na
12	<i>Amania baccifera</i>	+	+	na	±	-	+	+	na
13	<i>Ludwigia quadrifoliata</i>	+	+	+	±	-	na	+	+
14	<i>Commellina species</i>	+	-	+	+	- na	+	na	
15	<i>Marsilea quadrifoliata</i>	+	+	+	na	-	+	na	+
16	<i>Monochoria</i>	+	na	+	+	-	+	+	+
17	<i>Lindernia crustacea</i>	+	na	na	+	-	na	+	na
18	<i>Trianthema portulacastrum</i>	+	+	na	na	-	na	+	na
C. Sedges									
19	<i>Cyperus iria</i>	+	+	+	+	-	+	±	+
20	<i>C. difformis</i>	+	+	+	+	-	+	±	+
21	<i>C. rotundus</i>	+	-	±	±	-	±	na	±
22	<i>Fimbristylis miliacea</i>	+	+	+	+	-	+	+	+

NOTE: Pre-plant herbicides are designed to kill all species (including crops)²



Integrated weed management

Experiential learning

Book IX

This book covers critical topics for the principles and practice of integrated weed management (IWM) in the context of smallholder farming in the tropics, with emphasis on experiential and hands-on learning. This document provides a guide for facilitators of a rapid one-day training on IWM, including detailed instructions on how to facilitate a training, training material requirements, flip charts to facilitate discussions, and pre- and post-tests for training participants.

Bangladesh Agricultural Research Institute:

Joydebpur, Gazipur 1701, Bangladesh.

www.bari.gov.bd

Department of Agricultural Extension:

Khamarbari, Farmgate, Dhaka-1215, Bangladesh.

www.dae.gov.bd

International Maize and Wheat Improvement Center (CIMMYT):

Km. 45, Carretera.México-Veracruz, El Batán, Texcoco CP 56237. Edo. de México . Mexico.

www.cimmyt.org

International Rice Research Institute (IRRI):

DAPO Box 7777, Metro Manila 1301, Philippines.

www.irri.org

Fresno State University:

Department of Plant Science. California State University. 2415 E.

San Ramon Ave. MS A/S 72. Fresno, CA 93740. USA.

www.fresnostate.edu

Funded by



USAID
FROM THE AMERICAN PEOPLE

**BILL & MELINDA
GATES foundation**

Partners

